

MA 204*i*

Modular interfacing unit for Leuze Ident and
RS 232 devices on PROFIBUS DP

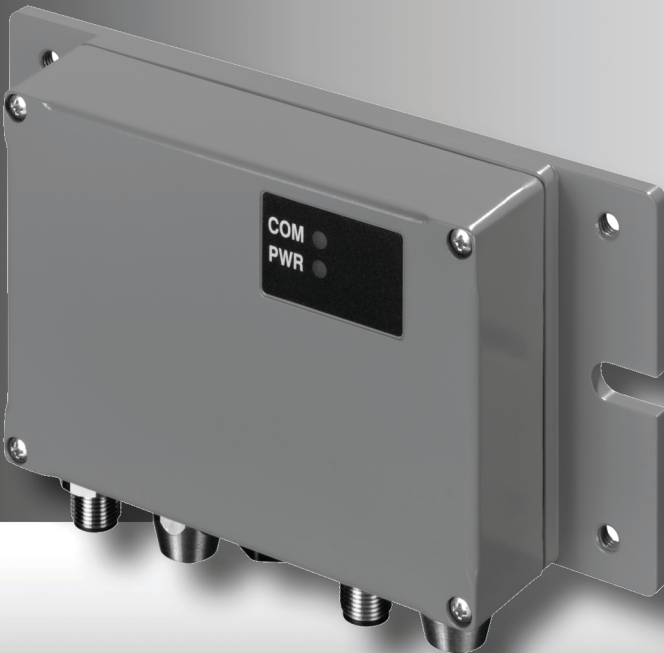

Sales and Service

Germany

Sales Region North

Phone 07021/573-306
Tel. Int. + 34 93 4097900
Fax 07021/9850950

Postal code areas
20000-38999
40000-65999
97000-97999

Sales Region South

Phone 07021/573-307
Tel. Int. + 34 93 94935820

Postal code areas
66000-96999

Sales Region East

Phone 035027/629-106
Fax 035027/629-107

Postal code areas
01000-19999
39000-39999
98000-99999

Worldwide

AR (Argentina)

Condelectric S.A.
Tel. Int. + 54 1148 361053
Fax Int. + 54 1148 361053

AT (Austria)

Schmachtl GmbH
Tel. Int. + 43 732 7646-0
Fax Int. + 43 732 7646-785

AU + NZ (Australia + New Zealand)

Balluff/Leuze Pty. Ltd.
Tel. Int. + 61 3 9720 4100
Fax Int. + 61 3 9738 2677

BE (Belgium)

Leuze electronic nv/sa
Tel. Int. + 32 2253 16-00
Fax Int. + 32 2253 15-36

BG (Bulgaria)

ATICS
Tel. Int. + 359 2 847 6244
Fax Int. + 359 2 847 6244

BR (Brazil)

Leuze electronic Ltda.
Tel. Int. + 55 11 5180-6130
Fax Int. + 55 11 5180-6141

CH (Switzerland)

Leuze electronic AG
Tel. Int. + 41 41 784 5656
Fax Int. + 41 41 784 5657

CL (Chile)

Imp. Tec. Vignola S.A.I.C.
Tel. Int. + 56 3235 11-11
Fax Int. + 56 3235 11-28

CN (China)

Leuze electronic Trading
(Shenzhen) Co. Ltd.
Tel. Int. + 86 755 862 64909
Fax Int. + 86 755 862 64901

CO (Colombia)

Componentes Electronicas Ltda.
Tel. Int. + 57 4 3511049
Fax Int. + 57 4 3511019

CZ (Czech Republic)

Schmachtl CZ s.r.o.
Tel. Int. + 420 244 0015-00
Fax Int. + 420 244 9107-00

DK (Denmark)

Leuze electronic Scandinavia ApS
Tel. Int. + 45 48 173200

ES (Spain)

Leuze electronic S.A.
Tel. Int. + 34 93 4097900
Fax Int. + 34 93 94935820

FI (Finland)

SKS-automatio Oy
Tel. Int. + 358 20 764-61
Fax Int. + 358 20 764-6820

FR (France)

Leuze electronic Sarl.
Tel. Int. + 33 160 0512-20
Fax Int. + 33 160 0503-65

GB (United Kingdom)

Leuze electronic Ltd.
Tel. Int. + 44 14 8040 85-00
Fax Int. + 44 14 8040 38-08

GR (Greece)

UTECO A.B.E.E.
Tel. Int. + 30 211 1206 900
Fax Int. + 30 211 1206 999

HK (Hong Kong)

Sensortech Company
Tel. Int. + 852 26510188
Fax Int. + 852 26510388

HR (Croatia)

Tipteh Zagreb d.o.o.
Tel. Int. + 385 1 381 6574
Fax Int. + 385 1 381 6577

HU (Hungary)

Kvaik Automatika Kft.
Tel. Int. + 36 1 272 2242
Fax Int. + 36 1 272 2244

ID (Indonesia)

P.T. Jabestindo Mitra Utama
Tel. Int. + 62 21 92861859
Fax Int. + 62 21 6451044

IL (Israel)

Galoz electronics Ltd.
Tel. Int. + 972 3 9023456
Fax Int. + 972 3 9021990

IN (India)

M + V Marketing Sales Pvt Ltd.
Tel. Int. + 91 124 4121623
Fax Int. + 91 124 434223

IT (Italy)

Leuze electronic S.r.l.
Tel. Int. + 39 02 26 1106-43
Fax Int. + 39 02 26 1106-40

JP (Japan)

C. Illies & Co., Ltd.
Tel. Int. + 81 3 3443 4143
Fax Int. + 81 3 3443 4118

KE (Kenia)

Profa-Tech Ltd.
Tel. Int. + 254 20 828095/6
Fax Int. + 254 20 828129

KR (South Korea)

Leuze electronic Co., Ltd.
Tel. Int. + 82 31 3828228
Fax Int. + 82 31 3828522

MK (Macedonia)

Tipteh d.o.o. Skopje
Tel. Int. + 389 70 399 474
Fax Int. + 389 23 174 197

MX (Mexico)

Movitren S.A.
Tel. Int. + 52 81 8371 9616
Fax Int. + 52 81 8371 8588

MY (Malaysia)

Ingermark (M) SDN.BHD
Tel. Int. + 60 360 3427-88
Fax Int. + 60 360 3421-88

NG (Nigeria)

SABROW HI-TECH E. & A. LTD.
Tel. Int. + 234 80333 86366
Fax Int. + 234 80333 84463518

NL (Netherlands)

Leuze electronic BV
Tel. Int. + 31 418 65 35-44
Fax Int. + 31 418 65 38-08

NO (Norway)

Elteco A/S
Tel. Int. + 47 35 56 20-70
Fax Int. + 47 35 56 20-99

PL (Poland)

Balluff Sp. z o. o.
Tel. Int. + 48 71 338 49 29
Fax Int. + 48 71 338 49 30

PT (Portugal)

LA2P, Lda.
Tel. Int. + 351 21 4 447070
Fax Int. + 351 21 4 447075

RO (Romania)

O BOYLE s.r.l.
Tel. Int. + 40 2 56201346
Fax Int. + 40 2 56221036

RS (Republic of Serbia)

Tipteh d.o.o. Beograd
Tel. Int. + 381 11 3131 057
Fax Int. + 381 11 3131 326

RU (Russian Federation)

ALL IMPEX 2001
Tel. Int. + 7 495 9213012
Fax Int. + 7 495 6462092

SE (Sweden)

Leuze electronic Scandinavia ApS
Tel. Int. + 46 380 490951

SG + PH (Singapore + Philippines)

Balluff Asia Pte Ltd
Tel. Int. + 65 6252 43-84
Fax Int. + 65 6252 90-60

SI (Slovenia)

Tipteh d.o.o.
Tel. Int. + 386 1200 51-50
Fax Int. + 386 1200 51-51

SK (Slovakia)

Schmachtl SK s.r.o.
Tel. Int. + 421 2 58275600
Fax Int. + 421 2 58275601

TH (Thailand)

Industrial Electrical Co. Ltd.
Tel. Int. + 66 2 642 6700
Fax Int. + 66 2 642 4250

TR (Turkey)

Leuze electronic San ve Tic.Ltd.Siti.
Tel. Int. + 90 216 456 6704
Fax Int. + 90 216 456 3650

TW (Taiwan)

Great Colvue Technology Co., Ltd.
Tel. Int. + 886 2 2983 80-77
Fax Int. + 886 2 2985 33-73

UA (Ukraine)

SV Altera OOO
Tel. Int. + 38 044 4961888
Fax Int. + 38 044 4961818

US + CA (United States + Canada)

Leuze electronic, Inc.
Tel. Int. + 1 248 486-4466
Fax Int. + 1 248 486-6699

ZA (South Africa)

Countapulse Controls (PTY). Ltd.
Tel. Int. + 27 116 1575-56
Fax Int. + 27 116 1575-13

1	General information	6
1.1	Explanation of symbols	6
1.2	Declaration of conformity	6
1.3	Description of functions	7
1.4	Definition of Terms	8
2	Safety notices	9
2.1	General safety notices	9
2.2	Safety standards	9
2.3	Intended use	9
2.4	Working safely	10
3	Fast commissioning / operating principle	11
3.1	Mounting	11
3.2	Device arrangement and selection of the mounting location	11
3.3	Electrical connection	11
3.3.1	Connecting the Leuze device	12
3.3.2	Setting the PROFIBUS device address	12
3.3.3	Connecting the power supply and the bus cable	13
3.4	Starting the device	13
3.5	Commissioning the MA 204 <i>i</i> on the PROFIBUS DP	13
3.5.1	Preparing the control system	13
3.5.2	Installation of the GSD file	14
3.5.3	Configuration	14
3.5.4	Configuration of the modules	15
3.5.5	Transmission of the configuration to the controller	15
4	Device description	16
4.1	General Information to the connector units	16
4.2	Characteristics of the connector units	16
4.3	Device construction	17
4.4	Operating modes	18
4.5	Fieldbus systems	19
4.5.1	PROFIBUS DP	19

5	Specifications	21
5.1	General specifications	21
5.2	Dimensioned drawings	22
5.3	Type overview	23
6	Installation and mounting	24
6.1	Storage, transportation	24
6.2	Mounting	25
6.3	Device arrangement	26
6.3.1	Selecting a mounting location	26
6.4	Cleaning	26
7	Electrical connection	27
7.1	Safety notices for the electrical connection	27
7.2	Electrical connection	28
7.2.1	PWR IN – voltage supply / switching input/output	28
7.2.2	PWR OUT switching input/output	30
7.3	BUS IN	30
7.4	BUS OUT	31
7.4.1	PROFIBUS termination	31
7.5	Device interfaces	32
7.5.1	RS 232 device interface (accessible after opening the device, internal)	32
7.5.2	Service interface (internal)	33
8	Status displays and operational controls	34
8.1	LED status indicators	34
8.1.1	LED indicators on the circuit board	34
8.1.2	LED indicators on the housing	35
8.2	Internal interfaces and operational controls	36
8.2.1	Overview of operational controls of the	36
8.2.2	Connector X30 ... connectors	38
8.2.3	RS 232 service interface – X33	38
8.2.4	S10 service switch	38
8.2.5	Rotary switch S4 for device selection	39
8.2.6	Switch for address selection in the fieldbus	40

9	Configuration	41
9.1	Connecting the service interface	41
9.2	Reading out information in service mode	41
10	Telegram	44
10.1	Structure of the fieldbus telegram	44
10.2	Description of the input bytes (status bytes)	45
10.2.1	Structure and meaning of the input bytes (status bytes)	45
10.2.2	Detailed description of the bits (input byte 0)	46
10.2.3	Detailed description of the bits (input byte 1)	48
10.3	Description of the output bytes (control bytes)	48
10.3.1	Structure and meaning of the output bytes (control bytes)	48
10.3.2	Detailed description of the bits (output byte 0)	49
10.3.3	Detailed description of the bits (output byte 1)	50
10.4	Delete RESET function / memory	51
11	Modes	52
11.1	Functionality of the data exchange	52
11.1.1	Reading slave data in Collective mode (gateway -> PLC)	52
11.1.2	W-ACK	53
11.1.3	Command mode	56
12	Commissioning and configuration	59
12.1	Measures to be performed prior to the initial commissioning	59
12.2	Starting the device	60
12.3	Configuration steps for a Siemens Simatic S7 control	60
12.3.1	Step 1 – Preparing the control system (S7 PLC)	61
12.3.2	Step 2 – Installation of the GSD file	61
12.3.3	Step 3 – Hardware configuration of the S7 PLC: Configuration	62
12.3.4	Step 4 – Configuration of the modules	62
12.3.5	Step 5 – Transmission of the configuration to the controller (S7 PLC)	64
12.4	Commissioning via the PROFIBUS DP	64
12.5	General information on the PROFIBUS implementation of the MA 204 <i>i</i>	64
12.5.1	Communication profile	64
12.5.2	Bus-access protocol	64
12.5.3	Device types	65
12.5.4	Automatic baud rate detection	66
12.5.5	Modular structure of the parameter	66
12.5.6	Permanently defined parameters/device parameters	67

12.5.7	Overview of the project modules	68
12.5.8	Preparing the control system for consistent data transmission	69
12.6	Variable configuration of the communication data width	69
12.7	Setting the read parameters on the Leuze device	70
12.7.1	Specific feature for the use of hand-held scanners (bar code and 2D devices, combi devices with RFID)	71
12.7.2	Specific features in the operation of an RFM/RFI	72
13	Diagnostics and troubleshooting	73
13.1	General causes of errors	73
13.2	Interface errors	74
14	Type overview and accessories	75
14.1	Type key	75
14.2	Type overview	75
14.3	Accessory terminating resistor	75
14.4	Accessory connectors	75
14.5	Accessory ready-made cables for voltage supply	76
14.5.1	Contact assignment of PWR connection cable	76
14.5.2	Specifications of the cables for voltage supply	76
14.5.3	Order codes of the cables for voltage supply	77
14.6	Accessory ready-made cables for bus connection	77
14.6.1	General information	77
14.6.2	Contact assignment of M12-PROFIBUS connection cable KB PB....	77
14.6.3	Specifications of M12-PROFIBUS connection cable KB PB....	78
14.6.4	Order codes of M12-PROFIBUS connection cable KB PB....	78
14.7	Accessory ready-made cables for connecting Leuze ident devices	79
14.7.1	Order codes for the device connection cables	79
14.7.2	Contact assignment for the device connection cables	79
15	Maintenance	80
15.1	General maintenance information	80
15.2	Repairs, servicing	80
15.3	Disassembling, packing, disposing	80
16	Specifications for Leuze end devices	81
16.1	Standard setting, KONTURflex (S4 switch position 0)	81
16.2	Bar code reader BCL 8 (S4 switch position 1)	83

16.3	Bar code reader BCL 22 (S4 switch position 2)	84
16.4	Bar code reader BCL 32 (S4 switch position 3)	85
16.5	Bar code reader BCL 300i, BCL 500i (S4 switch position 4)	86
16.6	Bar code reader BCL 90 (S4 switch position 5)	87
16.7	LSIS 122 (S4 switch position 6)	88
16.8	LSIS 4x2i (S4 switch position 7)	89
16.9	Hand-held scanner (S4 switch position 8)	90
16.10	RFI, RFM, RFU RFID readers (S4 switch position 9)	91
16.11	BPS 8 bar code positioning system (S4 switch position A)	92
16.12	AMS distance measurement device, ODSL xx optical distance sensors with RS 232 interface (S4 switch position B)	93
16.13	Modular interfacing unit MA 3x (S4 switch position C)	95
17	Appendix.	96
17.1	ASCII table	96

1 General information

1.1 Explanation of symbols

The symbols used in this operating manual are explained below.



Attention!

This symbol precedes text messages which must strictly be observed. Failure to comply with this information results in injuries to personnel or damage to the equipment.



Notice!

This symbol indicates text passages containing important information.

1.2 Declaration of conformity

The MA 204*i* modular interfacing units have been designed and manufactured in accordance with applicable European directives and standards.



Notice!

The Declaration of Conformity for these devices can be requested from the manufacturer.

The manufacturer of the product, Leuze electronic GmbH + Co. KG in D-73277 Owen, possesses a certified quality assurance system in accordance with ISO 9001.



1.3 Description of functions

The MA 204*i* modular interfacing unit is used to connect Leuze devices directly to the fieldbus.

Bar code reader:	BCL 8, 22, 32, 300i, 500i, 90
2D code reader:	LSIS 122, LSIS 4x2i
Hand-held scanner	ITxxxx, HFU/HFM
RFID read-write devices:	RFM 12, 32, 62 & RFI 32, RFU 61, 81
Bar code positioning system:	BPS 8
Distance measurement device:	AMS 200
Optical distance sensors:	ODSL 9, ODSL 30, ODSL 96B
Measuring light curtain:	KONTURflex to Quattro-RSX/M12
MultiNet master connection box:	MA 3x
Additional RS 232 devices:	Scales, third-party devices

This is accomplished by transmitting the data from the DEV via an RS 232 (V.24) interface to the MA 204*i* where a module converts it into the PROFIBUS DP format. The data format on the RS 232 interface corresponds to the Leuze standard data format (9600bd, 8N1 and STX, data, CR, LF).

The integration of the GSD file in the hardware manager of the PLC is necessary to ensure the correct function of the MA 204*i*.

The corresponding Leuze devices are selected using a rotary code switch on the circuit board of the connector unit. Many additional RS 232 devices can be connected through a universal position.

1.4 Definition of Terms

For better understanding of the explanations provided in this document, a definition of terms follows below:

- **Bit designation:**

The 1st bit or byte begins with count number "0" and means bit/byte 2^0 .

- **Data length:**

Size of a valid, continuous data packet in bytes.

- **EDS file (electronic data sheet):**

Description of the device for the control.

- **Consistent:**

Data which belongs together with regard to content and which must not be separated is referred to as consistent data. When identifying objects, it must be ensured that the data is transmitted completely and in the correct order, otherwise the result is falsified.

- **Leuze device (DEV):**

Leuze devices, e.g., bar code readers, RFID readers, VisionReader...

- **Online command:**

These commands refer to the respective, connected ident device and may be different depending on the device. These commands are not interpreted by the MA 204*i*, but are instead transmitted transparently (see description of ident device).

- **CR:**

Cross reference.

- **Perspective of I/O data in the description:**

Output data is data which is sent by the control to the MA. Input data is data which is sent by the MA to the control.

- **Toggle bits:**

- **Status toggle bit**

Each change of state indicates that an action was performed, e.g., bit ND (New Data): each change of state indicates that new received data was transmitted to the PLC.

- **Control toggle bit**

An action is performed on each change of state, e.g., bit SDO: on each change of state, the registered data is sent by the PLC to the MA 204*i*.

2 Safety notices

2.1 General safety notices

Documentation

All entries in this technical description must be heeded, in particular those in section "Safety notices". Keep this technical description in a safe place. It should be available at all times.

Safety regulations

Observe the locally applicable legal regulations and the rules of the employer's liability insurance association.

Repair

Repairs must only be carried out by the manufacturer or an authorized representative.

2.2 Safety standards

The devices of the series MA 2xx*i* were developed, manufactured and tested in accordance with the applicable safety standards. They correspond to the state of the art.

2.3 Intended use



Attention!

The protection of personnel and the device is guaranteed only if the device is operated in a manner corresponding to its intended use.

Areas of application

The MA 204*i* modular interfacing unit is used for connecting Leuze devices such as bar code- or 2D code readers, hand-held scanners, RFID read-write devices, etc. directly to the fieldbus. A detailed list can be found in "Description of functions" on page 7.

2.4 Working safely

**Attention!**

Access to or changes on the device, except where expressly described in this operating manual, are not authorized.

Safety regulations

Observe the locally applicable legal regulations and the rules of the employer's liability insurance association.

Qualified personnel

Mounting, commissioning and maintenance of the device must only be carried out by qualified personnel.

Electrical work must be carried out by a certified electrician.

3 Fast commissioning / operating principle



Notice!

Below you will find a **short description for the initial commissioning** of the PROFIBUS gateway MA 204*i*. Detailed explanations for the listed points can be found throughout the handbook.

3.1 Mounting

The gateway mounting plate MA 204*i* can be mounted in two different ways:

- using four threaded holes (M6) or
- using two M8x6 screws on the two lateral grooves.

3.2 Device arrangement and selection of the mounting location

Ideally, the MA 204*i* should be mounted so that it is easily accessible near the ident device in order to ensure good operability, e.g., for configuring the connected device.

Detailed information can be found in chapter 6.3.1.

3.3 Electrical connection

The devices from the MA 2xx*i* family feature four M 12 connectors/sockets which are coded differently depending on the interface.

The voltage supply (**PWR IN**) as well as the switching inputs/outputs (**PWR OUT** or **PWR IN**) are connected there. The number and function of the switching inputs/outputs is dependent on the connected end device.

An internal RS 232 interface is used for connecting the respective Leuze device. Another internal RS 232 interface functions as a service interface for configuring the connected device via a serial null modem cable.

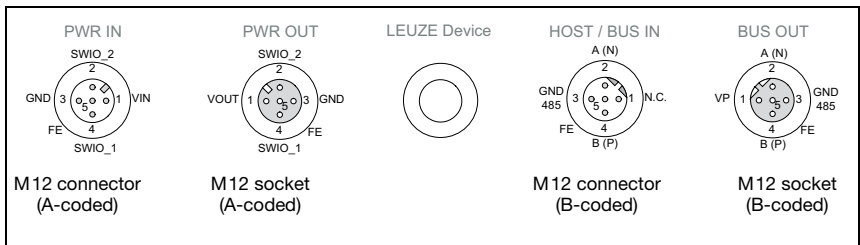

Figure 3.1: MA 204*i* connections

Detailed information can be found in chapter 7.

3.3.1 Connecting the Leuze device

- ✚ To connect the Leuze device to the internal RS 232 device interface, open the housing of the MA 204*i* and guide the corresponding device cable (see chapter 14.7, e.g., KB 031 for BCL 32) through the middle threaded opening.
- ✚ Connect the cable to the internal device interface (**X30**, **X31** or **X32**, see chapter 7.5.1).
- ✚ Use rotary switch **S4** (see chapter 8.2.5) to select the connected device.
- ✚ Now screw the PG cable gland into the threaded opening to provide strain relief and ensure protection class IP 65.

3.3.2 Setting the PROFIBUS device address

- ✚ Set the station address of the gateway via the rotary switch **S1** - **S3** (ones, tens and hundreds digits).



Notice!

The PROFIBUS permits an address range from 0 to 126. Address 126 must not be used for data communication. It may only be used temporarily for commissioning. Make certain that you assign each PROFIBUS participant a different PROFIBUS address.

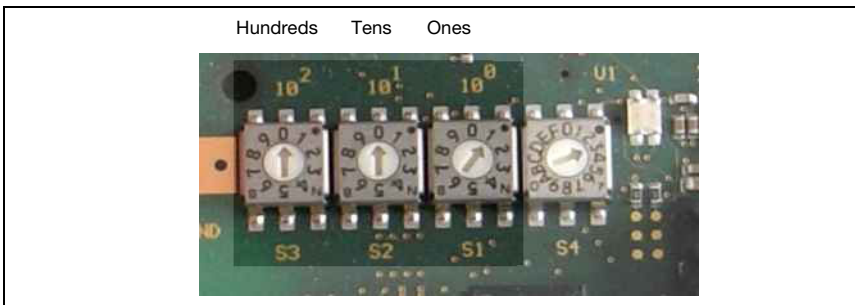

Figure 3.2: Rotary switch for setting the address

- ✚ Finally, close the housing of the MA 204*i*.



Attention!

Only then may the supply voltage be applied. Upon startup of the MA 204*i*, the device selection switch and the address settings are queried and the gateway automatically sets itself to the Leuze device.

Connecting functional earth FE

- ✚ Ensure that the functional earth (FE) is connected correctly.

Unimpaired operation is only guaranteed when the functional earth is connected properly. All electrical disturbances (EMC couplings) are discharged via the functional earth connection.

3.3.3 Connecting the power supply and the bus cable

- ↳ Ideally, use the ready-made cables listed in chapter 14.5.3 to connect the gateway to the power supply via the **PWR IN** connection.
- ↳ For the connection of the gateway to the fieldbus via the **HOST / BUS IN** connection, the ready-made cables listed in are preferred.
- ↳ If applicable, use the **BUS OUT** connection if you would like to construct a network with linear topology.

3.4 Starting the device

- ↳ Apply the supply voltage +18 ... 30VDC (+24VDC model).

The MA 204*i* starts up; the PWR LED displays that it is ready for operation.

3.5 Commissioning the MA 204*i* on the PROFIBUS DP

- ↳ Complete the necessary steps for commissioning a Siemens-S7 control as described below.

Further information regarding the individual commissioning steps is provided in see chapter 12.3 "Configuration steps for a Siemens Simatic S7 control".

3.5.1 Preparing the control system

- ↳ In the first step, prepare the control for consistent data transmission.

During programming the control system must be prepared for consistent data transmission. This varies from control system to control system. The following possibilities are available for the Siemens control systems.

S7

The specific function blocks SFC 14 for input data and SFC 15 for output data must be integrated in the program. These are standard function blocks and are used to facilitate consistent data transmission.



Notice!

If an S7 control is used, you need to ensure that Simatic-Manager Version 5.4 + service pack 5 (V5.4+SP5) or higher is used.

3.5.2 Installation of the GSD file

For the subsequent configuration of the PROFIBUS devices, e.g., MA 204*i*, the corresponding GSD file must be loaded first. All data in modules required for operating the device is described in this file. These are input and output data and device parameters for the functioning of the device and the definition of the control and status bits.

↳ Install the GSD file associated with the device in the PROFIBUS Manager of your control.

3.5.3 Configuration

↳ Configure the PROFIBUS system using the HW Config of the SIMATIC Manager by inserting the MA 204*i* into your project and assigning it a unique address (0 ... 125).



Notice!

Ensure that the address is the same as the address configured in the device.

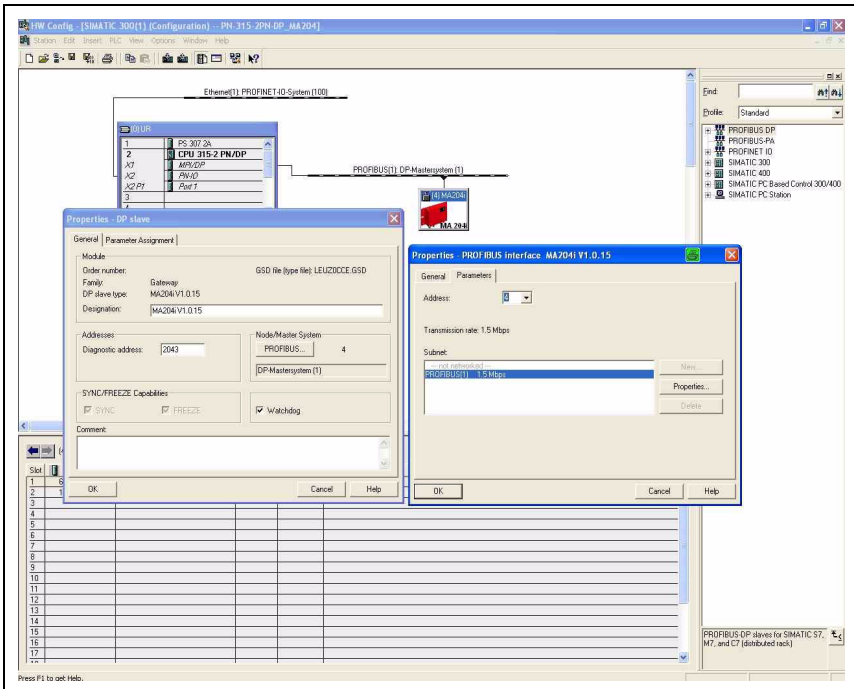

Figure 3.3: Assignment of the device address

3.5.4 Configuration of the modules

↳ Now select a corresponding data module for the input and output area.

A number of combinable modules are available with various data lengths (4, 8, 12, 16, 20, 32 ... 128 bytes). In total, a maximum of 244 bytes are possible for both the input bytes and for the output bytes.



Notice!

Because the data module contains 2 bytes for the control and status bytes, the actual user data length is always 2 bytes smaller than the selected data module.

E.g., when using the data module with 12 bytes, there are effectively 10 bytes available for user data on the Leuze device after subtracting the 2 bytes for status and control bytes.

Recommendation

In most cases, the 4-byte module is sufficient for the output module.

A larger module is needed, for example, if a BCL bar code scanner is to be configured by means of PT-sequences, or an RFID transponder is to be described. In these cases, larger data modules are usually sensible.



Notice!

Examples for selecting the correct data module length can be found in chapter 12.3.4, section "Examples of sensible settings for corresponding Leuze devices" on page 63.

3.5.5 Transmission of the configuration to the controller

↳ Transmit PROFIBUS configuration to the controller (S7 PLC).

After correct transmission to the controller (S7 PLC), the PLC automatically carries out the following activities:

- Establishment of a connection between the controller and configured PROFIBUS devices
- Cyclical data exchange

4 Device description

4.1 General Information to the connector units

The modular interfacing unit of the MA 2xx*i* family is a versatile gateway for integrating Leuze RS 232 devices (e.g., BCL 22 bar code readers, RFID devices, RFM 32, AMS 200) in the respective fieldbus. The MA 2xx*i* gateways are intended for use in industrial environments with a high protection class. Various device versions are available for the conventional fieldbuses. With a stored parameter structure for the connectable RS 232 devices, commissioning could hardly be simpler.

4.2 Characteristics of the connector units

A special characteristic of the MA 204*i* device family are three function modes:

1. Transparent mode

In this function mode, the MA 204*i* functions as a pure gateway with automatic communication from and to the PLC. Absolutely no special programming by the user is necessary for this purpose. The data is not buffered or stored temporarily, however. Instead, it is "passed on".

The programmer must make certain to retrieve the data from the input memory of the PLC at the right time, as it is otherwise overwritten by new data.

2. Collective mode

In this operating mode, data and telegram parts are temporarily stored in the memory (buffer) of the MA and sent to the RS 232 interface or to the PLC in a telegram by means of bit activation. In this mode, however, all communication control must be programmed on the PLC.

This function mode is helpful, for example, for very long telegrams or when one or more codes with long code lengths are read.

3. Command mode

With this special operating mode, it is possible to use the first bytes of the data range to transmit predefined commands to the connected device by means of bit activation. For this purpose, device-dependent commands (so-called online commands) are predefined via the device selection switch, see chapter 16 "Specifications for Leuze end devices".

4.3 Device construction

The MA 204*i* modular interfacing unit is used for interconnecting Leuze devices, such as the BCL 8, BCL 22, etc., directly to the fieldbus. This is accomplished by transmitting the data from the Leuze device via an RS 232 (V.24) interface to the MA 204*i* where a module converts it into the fieldbus format. The data format of the RS 232 interface corresponds to the standard Leuze data format.

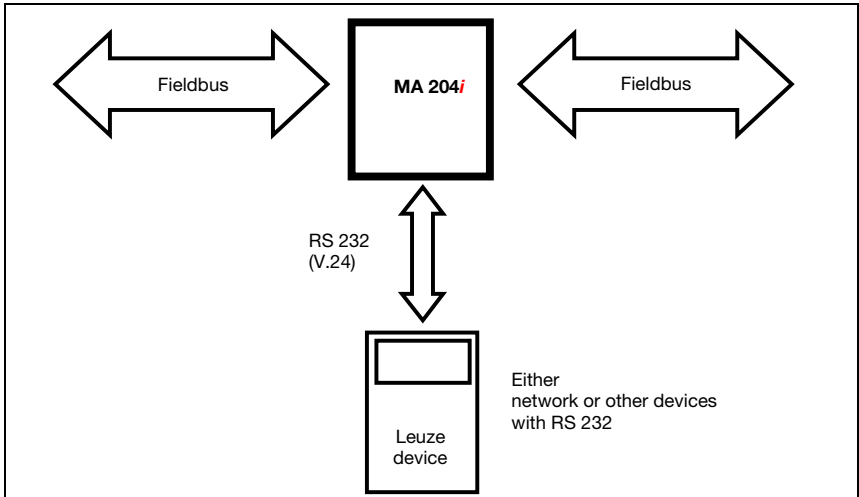

Figure 4.1: Connection of a Leuze devices (BCL, RFI, RFM, VR) to the fieldbus

The cable of the respective Leuze device is guided through cable bushings with PG cable glands into the MA 204*i* and connected there with the PCB connectors.

The MA 204*i* is intended as a gateway for any RS 232 devices, e.g., BCL 90 with MA 90, hand-held scanners, scales or for coupling a multiNet network.

The RS 232 cables are internally connectable using JST plug connectors. The cable can be connected to the device using a stable PG cable gland which provide strain relief and protection against contamination.

With the help of adapter cables with Sub-D 9 or open cable end, other RS 232 devices can also be connected.

4.4 Operating modes

For fast commissioning, the MA 204*i* offers an additional operating mode, the "Service mode", in addition to the "Standard mode". In this operating mode, the Leuze device can, for example, be configured on the MA 204*i* and the communication can be tested on the fieldbus. To do this, you need a PC/laptop with a suitable terminal program, as BCL-Config from Leuze or similar.

Service switch

Select between "operation" and "service" modes with the service switch. You have the following options:

Pos. RUN:

Operation

The Leuze device is connected to the fieldbus and communicates with the PLC.

Pos. DEV:

Service Leuze device

The connection between the Leuze device and the fieldbus is interrupted. With this switch position, you can communicate directly with the Leuze device at the fieldbus gateway via RS 232. You can send online commands via the service interface, configure the Leuze device using the corresponding BCL- BPS-, ...-Config configuration software and have the read data of the Leuze device output.

Pos. MA:

Service fieldbus gateway

With this switch setting, your PC/terminal is connected with the fieldbus gateway. In doing so, the current setting values of the MA (e.g. address, RS 232 parameters) can be called up via a command.

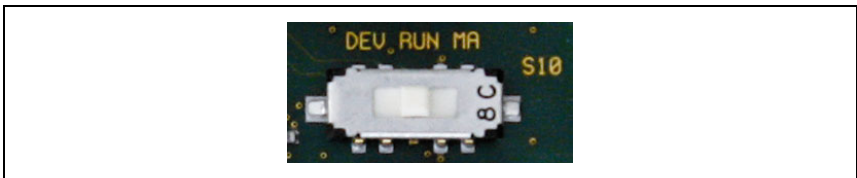

Figure 4.2: Service-switch switch positions



Notice!

If the service switch is on one of the service settings, the PWR LED flashes on the front side of the device, see chapter 8.1.2 "LED indicators on the housing".

Furthermore, on the control, the SMA service bit of the status bytes signals that the MA is in service mode.

Service interface

The service interface can be accessed once the MA 204*i* housing cover has been removed and features a 9-pin Sub-D connector (male). A crossed RS 232 connection cable is required to make the Rx/D, Tx/D and GND connections.

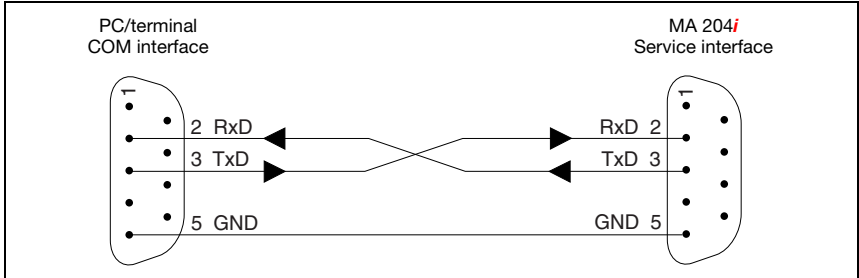

Figure 4.3: Connecting the service interface to a PC/terminal



Attention!

For the service PC to function, the RS 232 parameters must be the same as those of the MA. The Leuze standard setting of the interface is 9600bd, 8N1 and STX, data, CR, LF.

4.5 Fieldbus systems

Various product variants of the MA 2xx*i* series are available for connecting to different fieldbus systems such as PROFIBUS DP, PROFINET-IO, DeviceNet and Ethernet.

4.5.1 PROFIBUS DP

The MA 204*i* is designed as a PROFIBUS device (PROFIBUS DP-V0 acc. to IEC 61158) with a baud rate of max. 12MBd. The functionality of the device is defined via parameter sets which are clustered in modules. These modules are contained in a GSD file.

The MA 204*i* gateways can be operated as network devices on the PROFIBUS. The MA 204*i* features multiple M12 connectors / sockets for the electrical connection of the supply voltage, the interface and the switching inputs and outputs. Additional information on the electrical connection can be found in chapter 7.2.

The MA 204*i* supports:

- PROFIBUS-DP slave functionality
- Modular structure of the IO data
- Automatic baud rate detection up to 12 Mbit/s
- SYNC/FREEZE
- FailSafe Mode
- Device-specific diagnostic data
- I&M
- No changing of the slave address via the PROFIBUS

For further details, see chapter 12!

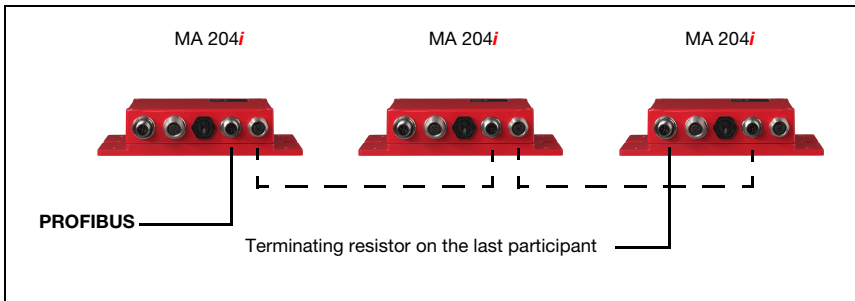

Figure 4.4: PROFIBUS DP

5 Specifications

5.1 General specifications

Electrical data

Interface type 1		PROFIBUS DP, BUS: 1x M12 connector (B-coded), 1x M12 socket (B-coded) PWR/IO: 1x M12 connector (A-coded), 1x M12 socket (A-coded)
	Protocols	PROFIBUS DP-V0
	Baud rate	9.6kBd ... 12MBd
Interface type 2		RS 232
	Baud rate	300bit/s ... 115200bit/s, default: 9600
Service interface		RS 232, 9-pin Sub-D connector, Leuze standard
	Data format	data bit: 8, parity: None, stop bit: 1
Switching input/output		1 switching input/1 switching output device-dependent voltage
Operating voltage		18 ... 30VDC
Power consumption		max. 5VA (without DEV, current consumption max. 300mA)
Max stress on the connector (PWR IN/OUT)		3A

Indicators

COM LED	green	Bus state ok
	red	Bus error
PWR LED	green	Power
	red	Collection error

Mechanical data

Protection class	IP 65 (with screwed-on M12 and connected Leuze device)
Weight	700 g
Dimensions (WxHxD)	130 x 90 x 41 mm / with plate: 180 x 108 x 41 mm
Housing	diecast aluminum
Connection	2 x M12: BUS IN / BUS OUT PROFIBUS DP 1 connector: RS 232 1 x M12: Power IN/GND and switching input/output 1 x M12: Power OUT/GND and switching input/output

Environmental data

Operating temperature range	0°C ... +55°C
Storage temperature range	-20°C ... +60°C
Air humidity	max. 90% rel. humidity, non-condensing

Vibration	IEC 60068-2-6, test FC
Shock	IEC 60068-2-27, test Ea
Electromagnetic compatibility	EN 61000-6-3:2007 (interference emissions for residential, commercial and light-industrial environments) EN 61000-6-2:2005 (interference rejection for industrial sectors)

5.2 Dimensioned drawings

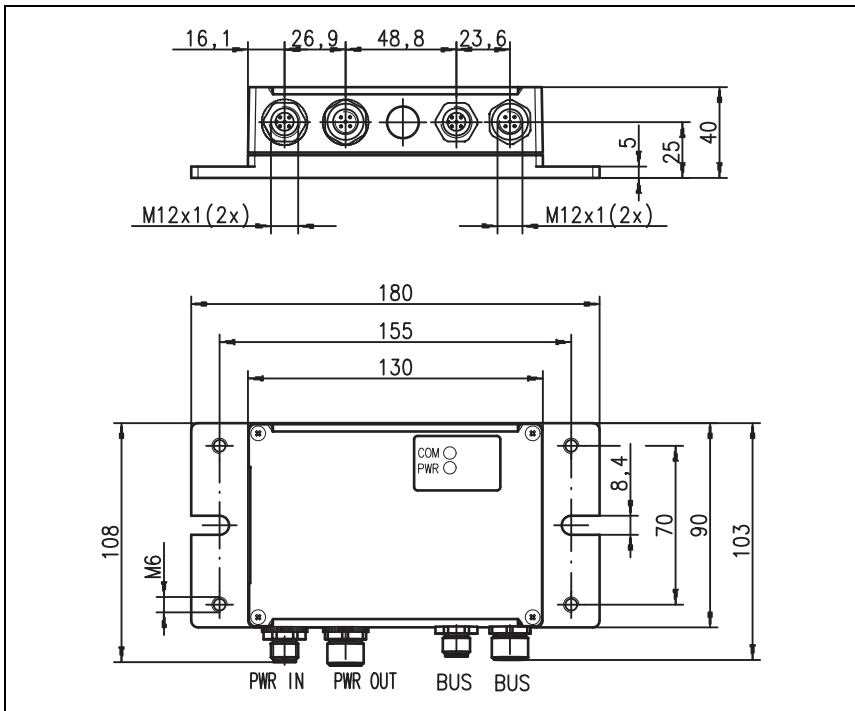

Figure 5.1: Dimensioned drawing MA 204*i*

5.3 Type overview

The following versions of the MA 2xx*i* gateway family are available for facilitating the integration of Leuze RS 232 devices in the various fieldbus types.

Fieldbus	Device type	Part no.
PROFIBUS DP V0	MA 204 <i>i</i>	50112893
EtherNet TCP/IP	MA 208 <i>i</i>	50112892
PROFINET-IO RT	MA 248 <i>i</i>	50112891
DeviceNet	MA 255 <i>i</i>	50114156
CANopen	MA 235 <i>i</i>	50114154
EtherCAT	MA 238 <i>i</i>	50114155
EtherNet/IP	MA 258 <i>i</i>	50114157

Table 5.1: Type overview MA 2xx*i*

6 Installation and mounting

6.1 Storage, transportation



Attention!

When transporting or storing, package the device so that it is protected against collision and humidity. Optimum protection is achieved when using the original packaging. Heed the required environmental conditions specified in the technical data.

Unpacking

- ↳ Check the packaging for any damage. If damage is found, notify the post office or shipping agent as well as the supplier.
- ↳ Check the delivery contents using your order and the delivery papers:
 - Delivered quantity
 - Device type and model as indicated on the nameplate
 - Brief manual

The name plate provides information as to what MA 2xx*i* type your device is. For specific information, please refer to the package insert or chapter 14.2.

Name plate of the connector unit



Figure 6.1: Device name plate MA 204*i*

- ↳ Save the original packaging for later storage or shipping.

If you have any questions concerning your shipment, please contact your supplier or your local Leuze electronic sales office.

- ↳ Observe the applicable local regulations when disposing of the packaging materials.

6.2 Mounting

The gateway mounting plate MA 204*i* can be mounted in two different ways:

- using four threaded holes (M6) or
- Using two M8 screws on the two lateral grooves.

Fastening by means of four M6 or two M8 screws



Figure 6.2: Fastening options

6.3 Device arrangement

Ideally, the MA 204*i* should be mounted so that it is easily accessible near the ident device in order to ensure good operability, e.g., for configuring the connected device.

6.3.1 Selecting a mounting location

In order to select the right mounting location, several factors must be considered:

- The permissible cable lengths between the MA 204*i* and the host system depending on which interface is used.
- The housing cover should be easily accessible, so that the internal interfaces (device interface for connecting the Leuze device via PCB connectors, service interface) and other operational controls are easy to reach.
- Maintaining the required environmental conditions (temperature, humidity).
- Lowest possible chance of damage to the MA 204*i* by mechanical collision or jammed parts.

6.4 Cleaning

 Clean the housing of the MA 204*i* with a soft cloth after mounting. Remove all packaging remains, e.g., carton fibers or Styrofoam balls.



Attention!

Do not use aggressive cleaning agents such as thinner or acetone for cleaning the device.

7 Electrical connection

The fieldbus gateways MA 2xx*i* are connected using coded M12 connectors.

An RS 232 device interface allows the respective devices to be connected with system connectors. The device cables are equipped with a prefabricated PG cable gland.

Coding varies and the design is implemented as either socket or connector depending on the HOST (fieldbus) interface and function. For the exact design, refer to the corresponding description of the MA 2xx*i* device type.



Notice!

The corresponding mating connectors and ready-made cables are available as accessories for all cables. For further information, see chapter 14 "Type overview and accessories".



Figure 7.1: Location of the electrical connections

7.1 Safety notices for the electrical connection



Attention!

Before connecting the device, be sure that the supply voltage agrees with the value printed on the name plate.

Connection of the device and cleaning must only be carried out by a qualified electrician. Ensure that the functional earth (FE) is connected correctly. Unimpaired operation is only guaranteed when the functional earth is connected properly. If faults cannot be corrected, the device should be removed from operation and protected against possible use.



Attention!

For UL applications, use is permitted exclusively in Class 2 circuits according to NEC (National Electric Code).



The fieldbus gateways are designed in accordance with safety class III for supply by PELV (protective extra-low voltage with reliable disconnection).



Notice!

Protection class IP 65 is achieved only if the connectors and caps are screwed into place!

7.2 Electrical connection

The MA 204*i* features two M12 connectors/sockets for voltage supply; each is A-coded. The voltage supply (**PWR IN**) as well as the switching inputs/outputs (**PWR OUT** or **PWR IN**) are connected there. The number and function of the switching inputs/outputs is dependent on the connected end device. Two additional M12 connectors/sockets are used for connection to the fieldbus. Both of these connections are B-coded.

An internal RS 232 interface is used for connecting the respective Leuze device. Another internal RS 232 interface functions as a service interface for configuring the connected device via a serial null modem cable.

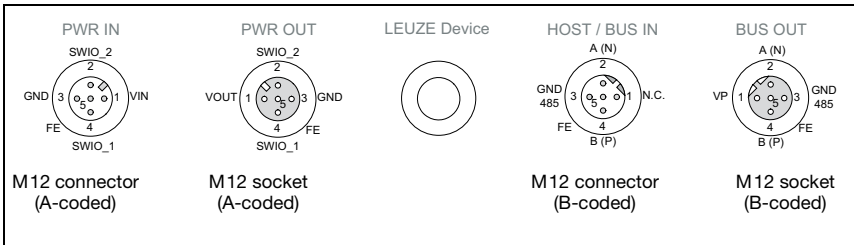

Figure 7.2: Connections of the MA 204*i*, view: laying on mounting plate

Described in detail in the following are the individual connections and pin assignments.

7.2.1 PWR IN – voltage supply / switching input/output

PWR IN (5-pin connector, A-coded)			
	Pin	Name	Remark
<p>PWR IN SWIO_2 VIN GND SWIO_1 FE M12 connector (A-coded)</p>	1	VIN	Positive supply voltage +18 ... +30VDC
	2	SWIO_2	Switching input/switching output 2
	3	GND	Negative supply voltage 0VDC
	4	SWIO_1	Switching input/switching output 1
	5	FE	Functional earth
	Thread	FE	Functional earth (housing)

Table 7.1: Pin assignment PWR IN



Notice!

The designation and function of the SWIO depends on the connected device. Please observe the following table!

Device	PIN 2	PIN 4
BCL 22/BCL 32	SWOUT_1	SWIN_1
BCL 8	SW_0	SW_1
Hand-held scanner/BCL 90	n.c.	n.c.
RFM/RFU/RFI	SWOUT_1	SWIN_1
LSIS 122	SWOUT	SWIN
LSIS 4x2/BCL 500	configurable IO 1 / SWIO 3 IO 2 / SWIO 4	configurable
KONTURflex	n.c.	n.c.
ODSL 9, ODSL 96B	Q1	n.c.
ODSL 30	Q1	active/reference (on SWIN_1, PWRIN)

Table 7.1: Device-specific function of the SWIOs

Supply voltage



Attention!

For UL applications, use is permitted exclusively in Class 2 circuits according to NEC (National Electric Code).



The fieldbus gateways are designed in accordance with safety class III for supply by PELV (protective extra-low voltage with reliable disconnection).

Connecting functional earth FE



Notice!

Ensure that the functional earth (FE) is connected correctly. Unimpaired operation is only guaranteed when the functional earth is connected properly. All electrical disturbances (EMC couplings) are discharged via the functional earth connection.

Switching input/output

The MA 204*i* is equipped with the **SWIO_1** and **SWIO_2** switching input/output. This is located on the PWR IN M12 connector and on the PWR OUT M12 connector. The connection of the switching inputs/outputs from PWR IN to PWR OUT can be interrupted by means of a jumper. In this case, only the switching input and output on PWR IN are active.

The function of the switching inputs and outputs is dependent on the connected Leuze device. Detailed information on this topic can be found in the respective operating instructions.

7.2.2 PWR OUT switching input/output

PWR OUT (5-pin socket, A-coded)			
	Pin	Name	Remark
	1	VOUT	Voltage supply for additional devices (VOUT identical to VIN at PWR IN)
	2	SWIO_2	Switching input/switching output 2
	3	GND	GND
	4	SWIO_1	Switching input/switching output 1
	5	FE	Functional earth
	Thread	FE	Functional earth (housing)

Table 7.2: Pin assignment PWR OUT



Notice!

The maximum admissible current of the PWR OUT and IN connectors is maximum 3A. To be subtracted from this is the current consumption of both the MA and of the connected end device.

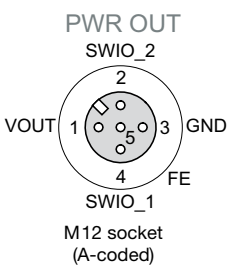
The function of the switching inputs and outputs is dependent on the connected Leuze device. Detailed information on this topic can be found in the respective operating instructions.

On delivery, the SWIO 1/2 are connected in parallel on PWR IN/OUT. This connection can be separated with a jumper.

7.3 BUS IN

The MA 204*i* provides a PROFIBUS DP interface as a HOST interface.



BUS IN (5-pin plug, B-coded)			
	Pin	Name	Remark
	1	N.C.	Not used
	2	A (N)	Receive/transmit data A-line (N)
	3	GND 485	RS 485 ground reference for bus termination
	4	B (P)	Receive/transmit data B-line (P)
	5	FE	Functional earth / shield
	Thread	FE	Functional earth (housing)

Table 7.3: Pin assignments for PROFIBUS DP BUS IN

 For the host connection of the MA 204*i*, the ready-made KB PB-xxxx-Bx cables are preferred, "Bus connection cable for the MA 204*i*" on page 78.

7.4 BUS OUT

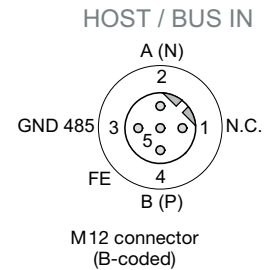
BUS OUT (5-pin socket, B-coded)			
BUS OUT	Pin	Name	Remark
 <p>A (N) 2 VCC 1 3 GND 485 4 FE B (P) M12 socket (B-coded)</p>	1	VCC	+5VDC for bus termination (termination)
	2	A (N)	Receive/transmit data A-line (N)
	3	GND 485	RS 485 ground reference for bus termination
	4	B (P)	Receive/transmit data B-line (P)
	5	FE	Functional earth / shield
	Thread	FE	Functional earth (housing)

Table 7.4: Pin assignments for PROFIBUS DP BUS OUT

↪ For the host connection of the MA 204*i*, the ready-made KB PB-xxxx-Sx cables are preferred, "Bus connection cable for the MA 204*i*" on page 78.

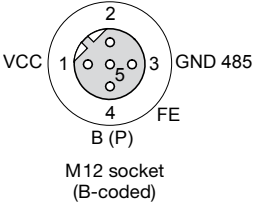

Notice!

Ensure adequate shielding. For the devices and ready-made cables offered by Leuze electronic, the shield is on PIN 1.

7.4.1 PROFIBUS termination

The last physical PROFIBUS participant must be terminated with a terminating resistor (see "Accessory terminating resistor" on page 75) on the BUS OUT socket.

7.5 Device interfaces

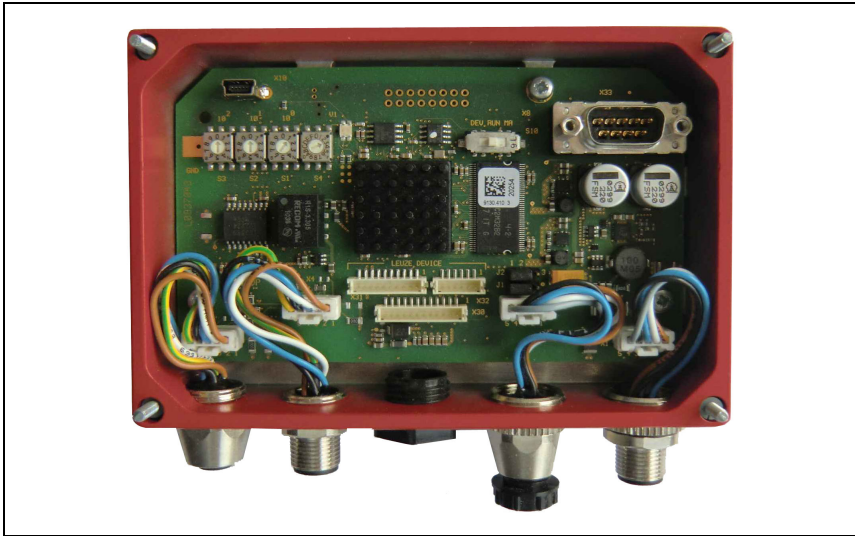

Figure 7.3: Open MA 204*i*

7.5.1 RS 232 device interface (accessible after opening the device, internal)

The device interface is prepared for the system plugs (PCB connectors) for Leuze devices RFI xx, RFM xx, BCL 22 as well as BCL 32, VR with KB 031.

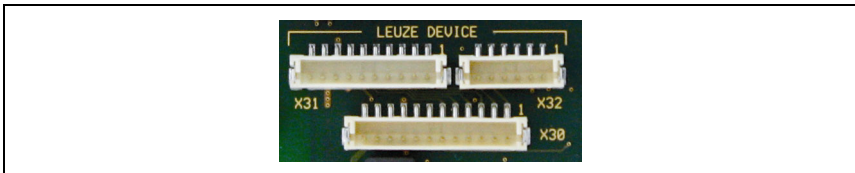

Figure 7.4: RS 232 device interface

The standard devices are connected with 6- or 10-pin connector piece to X31 or X32, respectively. For hand-held scanners, BCL 8 and BPS 8 with 5VDC supply (voltage supply from the MA) on pin 9, the 12-pin X30 PCB connection is available as well.

By using an additional cable (cf. "Type overview and accessories" on page 75), the system connection can be established on M12 or 9-pin Sub-D, e.g., for hand-held scanners.

7.5.2 Service interface (internal)

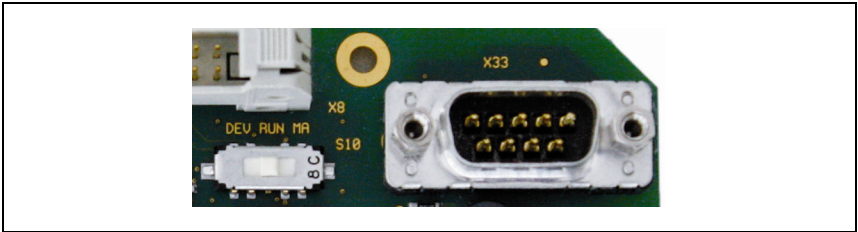

Figure 7.5: RS 232 service switch and service interface

Following activation, this interface enables access via the RS 232 to the connected Leuze device and the MA for configuration using the 9-pin Sub-D. The connection between the fieldbus interface and the device interface is switched off during access. The fieldbus itself is, however, not interrupted as a result.

The service interface can be accessed once the MA 204*i* housing cover has been removed and features a 9-pin Sub-D connector (male). A crossed RS 232 connection cable is required to make the RxD, TxD and GND connections. A hardware handshake via RTS, CTS is not supported at the service interface.

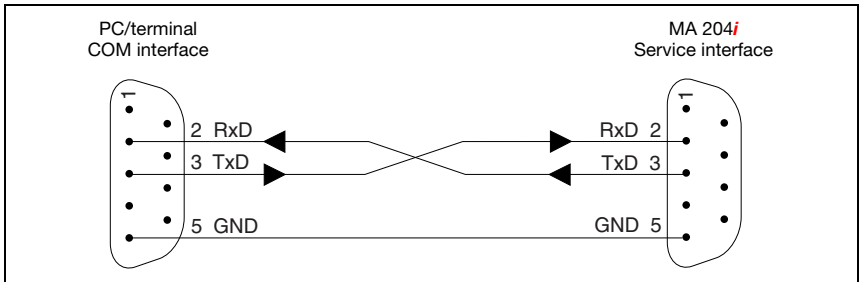

Figure 7.6: Connecting the service interface to a PC/terminal



Attention!

For the service PC to function, the RS 232 parameters must be the same as those of the MA. The Leuze standard setting of the interface is 9600Bd, 8N1 and STX, data, CR, LF.



Notice!

To configure the devices connected to the external interface, e.g., BCL 8 (JST plug connector "X30"), a cable specially configured for this purpose is necessary. The service switch must be in the "DEV" or "MA" position (Service Leuze device/MA).

8 Status displays and operational controls







Figure 8.1: LED indicators on the MA 204*i*

8.1 LED status indicators





8.1.1 LED indicators on the circuit board

LED (Status)





	off	Device OFF - no operating voltage or device defect
	continuous green light	Device ok - readiness for operation
	continuous orange light	Device error/ firmware available
	flashing green-orange	Device in boot mode - no firmware

8.1.2 LED indicators on the housing

COM LED

COM 	continuous green light	Bus operation ok - network mode ok - connection and communication to the host established
COM 	flashing green	Device ok - no connection to HOST - no termination
COM 	red continuous light	Network error - interference on PROFIBUS - no connection established - no communication possible
COM 	flashing red	Time exceeded during establishment of connection
COM 	flashing red/green/off	Self-test after switching on

PWR LED

PWR 	off	Device OFF - no operating voltage or device error
PWR 	continuous green light	Device ok - self test successfully finished - ready
PWR 	flashing green	Device ok, device in service mode
PWR 	red, flashing	Configuration error - baud rate or address incorrect

8.2 Internal interfaces and operational controls

8.2.1 Overview of operational controls of the

The operational controls of the MA 204*i* are described in the following. The figure shows the MA 204*i* with opened housing cover.

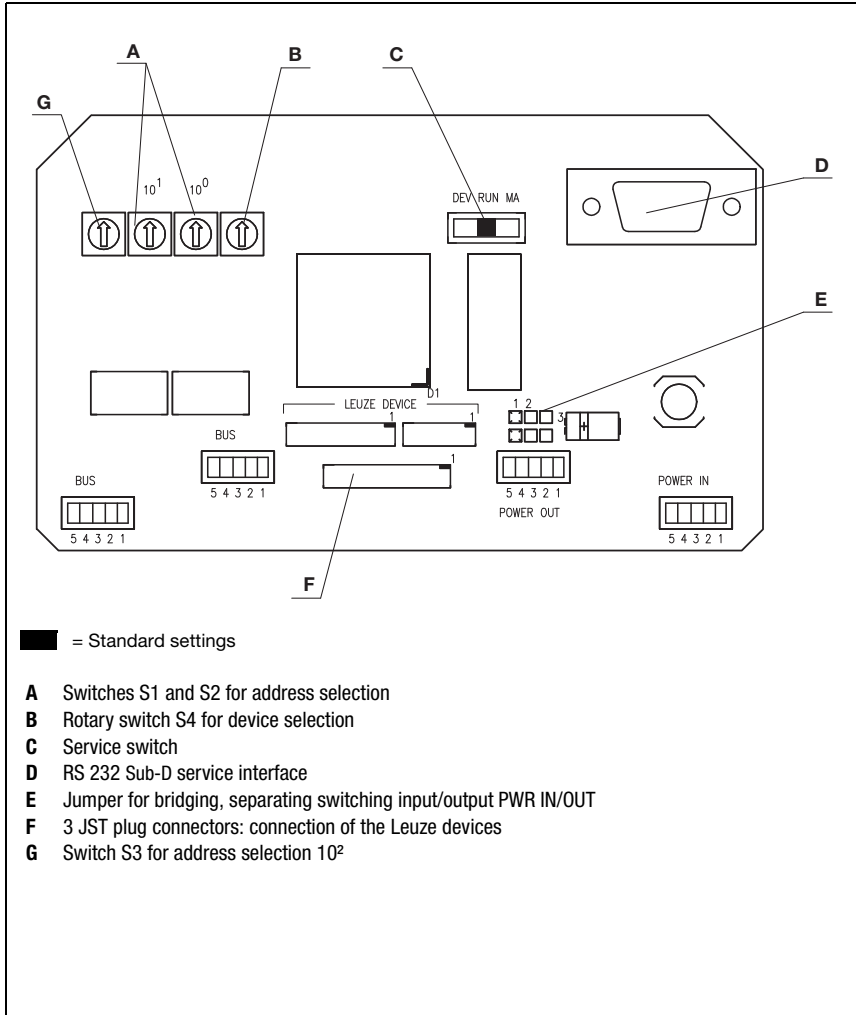

Figure 8.2: Front view: operational controls of the MA 204*i*

Circuit board element designation	Function
X1 Operating voltage	PWR IN M12 connector for operating voltage (18 ... 30VDC) MA 204 <i>i</i> and connected Leuze device xx
X2 Output voltage	PWR OUT M12 connector for other devices (MA, BCL, sensor, ...) VOUT = VIN max. 3A
X4 HOST interface	BUS IN HOST interface for connecting to the fieldbus
X5 HOST interface	BUS OUT Second BUS interface for creating a network with other participants in a linear topology
X30 Leuze device	JST plug connector with 12 pins Connection of the Leuze devices with 5V / 1A (BCL 8, BPS 8 and hand-held scanner)
X31 Leuze device	JST plug connector with 10 pins Connection of the Leuze devices (BCL, RFI, RFM,...) Pin VINBCL with default setting = V+ (18 - 30V)
X32 Leuze device	JST plug connector with 6 pins Connection of the Leuze devices (BCL, RFI, RFM,...) Pin VINBCL with default setting = V+ (18 - 30V)
X33 RS 232 service interface	9-pin SUB-D connector RS 232 interface for service/setup operation. Enables the connection of a PC via serial null modem cable for configuring the Leuze device and the MA 204 <i>i</i> .
S4 Rotary switch	Rotary switch (0 ... F) for device selection Default setting = 0
S10 DIP switch	Service switch Switch between service Leuze device (DEV), service fieldbus gateway (MA) and operation (RUN). Standard setting = operation.
J1, J2 Jumper	Bridging, separating switching input/output (interruption of connection between the two PWR M12 connectors of the SWIO 1/SWIO 2)
S1 Rotary switch	Rotary switch (0 ... 9) for address selection 10 [^] 0 Default setting: position 0
S2 Rotary switch	Rotary switch (0 ... 9) for address selection 10 [^] 1 Default setting: position 0
S3 Rotary switch	Switch for address selection – switch between address range 0...99 or 100...127; default setting: address range = 0...99

8.2.2 Connector X30 ... connectors

PCB connectors **X30 ... X32** are available in the MA 204*i* for connecting the respective Leuze devices via RS 232.

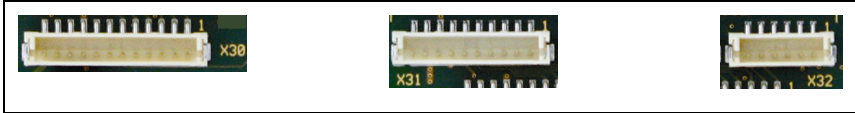

Figure 8.3: Connections for Leuze devices



Attention!

Several Leuze devices may not be connected to the MA 204*i* simultaneously, as only one RS 232 interface can be operated.

8.2.3 RS 232 service interface – X33

The **X33** RS 232 interface facilitates the configuration of the Leuze device and the MA 204*i* via PC, which is connected by means of a serial null modem cable.

X33 pin assignment – service connector

SERVICE (9-pin SUB-D connector)			
	Pin	Name	Remark
	2	RXD	Receive Data
	3	TXD	Transmit Data
	5	GND	Functional earth

Table 8.1: SERVICE pin assignment

8.2.4 S10 service switch

The **S10** DIP switch can be used to select between the "operation" and "service" modes, i.e. you switch between the following options here:

- Operation (RUN) = default setting
- Service Leuze device (DEV) and
- Service fieldbus gateway (MA)

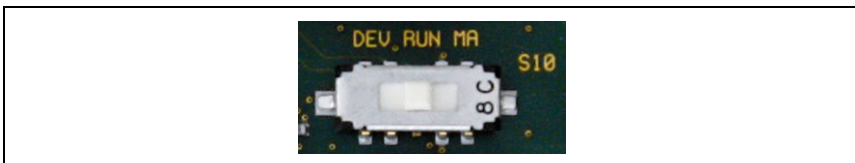

Figure 8.4: DIP switch service - operation

For further information on the corresponding options, see chapter 4.4 "Operating modes".

8.2.5 Rotary switch S4 for device selection

The **S4** rotary switch is used to select the Leuze end device.



Figure 8.5: Rotary switch for device selection

The following switch positions are assigned to the Leuze devices:

Leuze device	Switch position
Standard setting	
Other RS 232 devices such as KONTURflex QUATTRO	0
BCL 8	1
BCL 22	2
BCL 32	3
BCL 300i, BCL 500i	4
BCL 90	5
LSIS 122	6

Leuze device	Switch position
LSIS 4x2i	7
Hand scanner	8
RFID (RFI xx, RFM xx, RFU xx)	9
BPS 8	A
AMS, ODS 9, ODSL 30, ODSL 96B	B
MA 3x	C

The gateway is set via the switch position on the Leuze device. If the switch position is changed, the device must be restarted, since the switch position is only queried after switching off completely and then restarting the device.



Note!

In switch position "0", a distance of >20ms must be maintained between two telegrams so they can be distinguished from one another.

The parameters of the Leuze end devices are described in chapter 16.

Additional parameters such as the baud rate and data mode can be configured via the GSD file with the "USE GSD settings" enable function. The data frame and, if necessary, the length are specified via the switch position.

8.2.6 Switch for address selection in the fieldbus

The gateway features the **S1**, **S2** and **S3** switches (ones, tens and hundreds digits) for setting the station address.

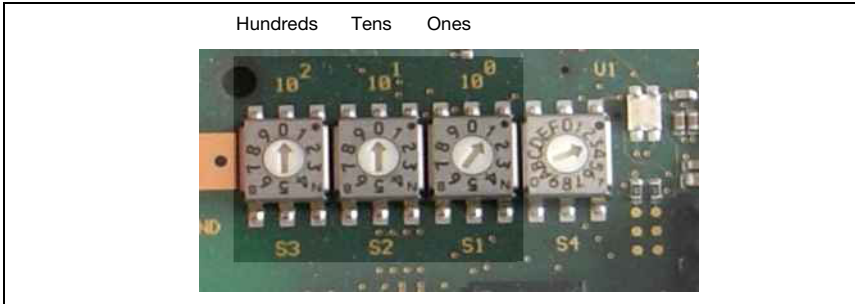

Figure 8.6: Rotary switch for setting the address

Further information on the respective address ranges and the addressing procedure can be found in chapter 12.1.

9 Configuration

The MA 204*i* is configured using the GSD file via the device manager of the control. The connected device is normally configured via the service interface of the MA with the help of a suitable configuration program.

The respective configuration programs – e.g. for bar code readers the BCL-Config, for RFID devices the RF-Config etc. – and the associated documentation is provided on the Leuze home page in the Download area:

[www.leuze.de \ download \ identify](http://www.leuze.de/download/identify)



Notice!

In order to display the help texts, a PDF viewer program (not included in the delivery contents) must also be installed. For important information on configuring and on the configurable functions, please refer to the description of the respective device.

9.1 Connecting the service interface

The RS 232 service interface is connected after opening the device cover of the MA 204*i* via the 9-pin Sub-D and a cross-wired null modem cable (RxD/TXD/GND). For connection, see chapter "Service interface (internal)" on page 33.

The service interface is activated with the help of the service switch and establishes a direct connection to the connected device with the "DEV" (Leuze device) or "MA" (gateway) setting.

9.2 Reading out information in service mode

- ↳ *After starting up in the "RUN" switch position, set the service switch of the MA to the "MA" position.*
- ↳ *Now start one of the following terminal programs: e.g., BCL, RF, BPS Config.*
Alternatively, you can also use the Windows tool "Hyperterminal".
- ↳ *Start the program.*
- ↳ *Select the correct COM port (e.g., COM1) and set the interface as follows:*

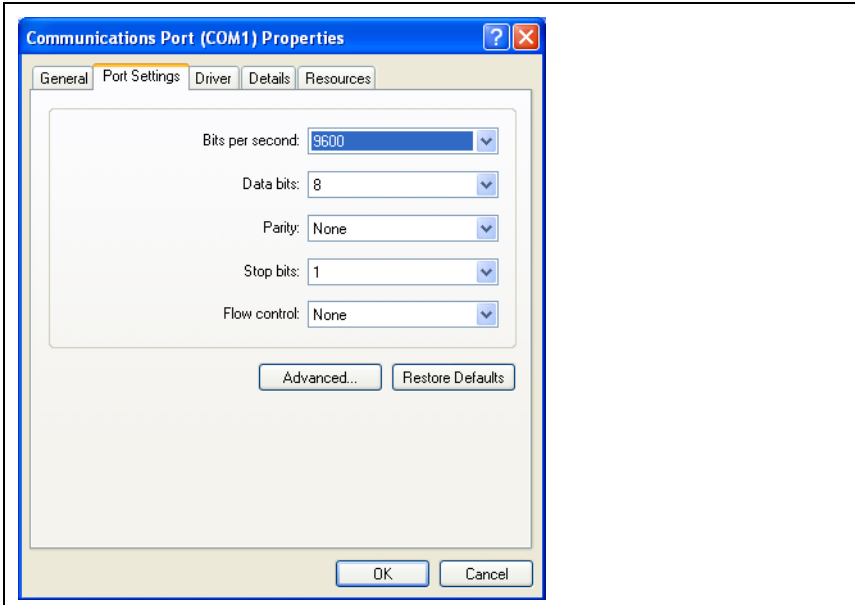

Figure 9.1: COM port settings



Notice!

Observe that *STX*, *data*, *CR*, *LF* framing must be set on the PC terminal program so that communication is possible with the connected Leuze device.

Commands

You can now call up information on the MA 204*f* by sending the following commands.

v	General service information.
s	Enable memory mode for the last frames.
l	The memory mode shows the last RX and TX frames for ASCII and fieldbus.

Table 9.1: Available commands

Information

Version	Version information.
Firmware date	Firmware date.

Table 9.2: General firmware information

Selected scanner	Currently selected Leuze device (selected via switch S4).
Gateway mode	Transparent or Collective mode.
Ring buffer fill level	Current fill level of the ring memory in Collective mode (ASCII->Fieldbus). 1024 bytes max.
Received ASCII Frames	Number of received ASCII frames.
ASCII Framing Error (GW)	Number of received framing errors.
Number of Received CTB's	Number of CTB commands.
Number of Received SFB's	Number of SFB commands.
Command-Buffer fill level	Current fill level of the ring memory in Command mode (fieldbus->ASCII). 1024 bytes max.
Number of received transparent frames	Number of received fieldbus frames without CTB/SFB.
Number of send fieldbus frames	Number of frames sent via the fieldbus.
Number of invalid commands	Number of invalid commands.
Number of ASCII stack send errors	Number of frames that the ASCII memory could not send.
Number of good ASCII send frames	Number of frames that the ASCII memory sent successfully.

Table 9.3: General gateway information

ND	Current status of ND bit.
W-Ack	Current status of W-Ack bit.
R-Ack	Current status R-Ack bit.
Data loss	Current status of data loss bit.
Ring buffer overflow	Current status of ring buffer overflow bit.
DEX	Current status of DEX bit.
BLR	Current status of BLR bit.

Table 9.4: Current states of the status and control bits

ASCII start byte	Currently configured start byte (dependent on switch position S4).
ASCII end byte1	Currently configured stop byte 1 (dependent on switch position S4).
ASCII end byte2	Currently configured stop byte 2 (dependent on switch position S4).
ASCII warm start status	Indicates whether the ASCII memory has detected and accepted a valid configuration.
ASCII baud rate	Currently configured baud rate (dependent on switch position S4).

Table 9.5: ASCII configuration

DPS reconfiguration request	Number of Profibus slave reconfigurations.
DPS input data length	Currently configured PROFIBUS input frame length in slot 1.
DPS output data length	Currently configured PROFIBUS output frame length in slot 2.
DPS address	Set Profibus address.
DPS identification number	Identification number of the Profibus slave.

Table 9.6: PROFIBUS configuration (only for MA 204*i* devices)

10 Telegram

10.1 Structure of the fieldbus telegram

All operations are performed by control and status bits. Two bytes of control information and two bytes of status information are available for this purpose. The control bits are a part of the output module and the status bits are a part of the input bytes. The data starts with the third byte.

If the actual data length is longer than the data length configured in the gateway, only part of the data is transmitted; the remaining data is lost. In this case, the DL (data loss) bit is set.

The following telegram structure is used between **PLC -> fieldbus gateway**:

7	6	5	4	3	2	1	0	
ND	Address 4	Address 3	Address 2	Address 1	Address 0	Broadcast	Command mode	Control byte 0
				CTB	SFB		R-ACK	Control byte 1
Data byte / parameter byte 0								Data
Data byte / parameter byte 1								
...								

This telegram structure is used between **fieldbus gateway -> PLC**:

7	6	5	4	3	2	1	0	
ND	B0	DL	BLR	DEX	SMA		W-ACK	Status byte 0
DLC7	DLC6	DLC5	DLC4	DLC3	DLC2	DLC1	DLC0	Status byte 1
Data byte / parameter byte 0								Data
Data byte / parameter byte 1								
...								

Only the data part with the corresponding frame (e.g., STX, CR & LF) is then transmitted between the fieldbus gateway and the Leuze end device. The two control bytes are processed by the fieldbus gateway.

The corresponding control and status bits and their meaning are specified in section 10.2 and section 10.3.

Further information on the broadcast control bytes and address bits 0 ... 4 can be found in chapter "Modular interfacing unit MA 3x (S4 switch position C)" on page 95.

10.2 Description of the input bytes (status bytes)

10.2.1 Structure and meaning of the input bytes (status bytes)

7	6	5	4	3	2	1	0	
ND	BO	DL	BLR	DEX	SMA		W-ACK	Status byte 0
DLC7	DLC6	DLC5	DLC4	DLC3	DLC2	DLC1	DLC0	Status byte 1
Data byte / parameter byte 0								
Data byte / parameter byte 1								Data
...								

Table 10.1: Structure of the input bytes (status bytes)

Bits of the input byte (status byte) 0

Bit no.	Designation	Meaning
0	W-ACK	Write-Acknowledge (write confirmation when using buffer)
2	SMA	Service mode active(service mode activated)
3	DEX	Data exist (data in transmit buffer)
4	BLR	Next block ready (new block ready)
5	DL	Data loss
6	BO	Buffer overflow
7	ND	New data only in Transparent mode

Bits of the input byte (status byte) 1

Bit no.	Designation	Meaning
0 ... 7	DLC0 ... DLC7	Data Length Code (length of the following user data)



Notice!

T-bit means toggle bit, i.e. this bit changes its state on each event ("0" → "1" or "1" → "0").

10.2.2 Detailed description of the bits (input byte 0)

Bit 0: Write-Acknowledge: W-ACK

This bit is only relevant for writing slave data in blocks, see chapter (buffer data on RS 232). It toggles when data from the PLC are sent to the MA with CTB or SFB.

Input data	Description	Addr.	Data type	Value range	Default
W-ACK	<p>Write-Acknowledge (write confirmation) Write handshake Indicates that the data was successfully sent by the PLC to the gateway. Write-Acknowledge is indicated via this bit. The W-ACK bit is toggled by the fieldbus gateway whenever a transmit command has been successfully executed. This applies both for the transmission of data to the transmit buffer with the CTB command and for sending the transmit buffer contents with the SFB command.</p>	0.0	Bit	<p>0->1: Successfully written 1->0: Successfully written</p>	0

Bit 2: Service mode active: SMA

Input data	Description	Addr.	Data type	Value range	Default
SMA	<p>Service mode active (SMA) The SMA bit is set if the service switch is set to "MA" or "DEV", i.e. if the device is in either fieldbus gateway or Leuze device service mode. This is also indicated by a flashing PWR LED on the front side of the device. Upon changing to the normal operating mode "RUN", the bit is reset.</p>	0.2	Bit	<p>0: Device in operating mode 1: Device in service mode</p>	0h

Bit 3: Data exist: DEX

This bit is only relevant for reading slave data in Collective mode relevant, see chapter 11.1.1.

Input data	Description	Addr.	Data type	Value range	Default
DEX	<p>Data exist (data in transmit buffer) Indicates that further data is stored in the transmit buffer which is ready for transmission to the control. This flag bit is always set to high ("1") by the fieldbus gateway as long as data is in the buffer.</p>	0.3	Bit	<p>0: No data in the transmit buffer 1: Further data in the transmit buffer</p>	0h

Bit 4: Next block ready to transmit: BLR

This bit is only relevant for reading slave data in Collective mode relevant, see chapter 11.1.1.

Input data	Description	Addr.	Data type	Value range	Default
BLR	Next block ready to transmit (new block ready) The Block Ready toggle bit changes its state whenever the fieldbus gateway has removed received data from the receive buffer and registered it in the corresponding receive-data bytes. This signals to the master that the quantity of data indicated in the DLC bits to be present in the input data bytes originated in the data buffer and is current.	0.4	Bit	0->1: Data transmitted 1->0: Data transmitted	0

Bit 5: Data loss: DL

This bit is important for monitoring data transmission in Transparent and Collective mode.

Input data	Description	Addr.	Data type	Value range	Default
DL	Data loss (Data transmission monitoring) This bit is set until the device is reset (bit pattern see chapter 10.4 "Delete RESET function / memory") in case gateway data was not able to be sent to the PLC and was lost. Furthermore, this bit is set in case the configured data frame, e.g. 8 bit, should be smaller than the data to be transmitted to the PLC, e.g. bar code with 20 digits. In this case, the first 8 digits are transmitted to the PLC, the rest are truncated and are lost. In this process, the Data loss bit is also set.	0.6	Bit	0->1: Data loss	0

Bit 6: Buffer overflow: BO

Input data	Description	Addr.	Data type	Value range	Default
BO	Buffer overflow (buffer overflow) This flag bit is set to high ("1") when the buffer overflows. The bit is automatically reset when the buffer again has memory space available. While the BO bit is set, the RTS signal of the serial interface is deactivated. The memory size of the gateway for the data of both the PLC and the Leuze end device is 1 kByte.	0.6	Bit	0->1: Buffer overflow 1->0: Buffer o.k.	0

Bit 7: New data: ND

This bit is only relevant in Transparent mode.

Input data	Description	Addr.	Data type	Value range	Default
ND	New data (new data) This bit is toggled on each data set that is sent from the gateway to the PLC. This can be used to differentiate between multiple, identical data sets that are sent to the PLC.	0.7	Bit	0->1; 1->0: On each status change for new data	0

10.2.3 Detailed description of the bits (input byte 1)

Bit 0 ... 7: Data length code: DLC0 ... DLC7

Input data	Description	Addr.	Data type	Value range	Default
DLC0 ... DLC7	Data length code (number of user data in bytes) Stored in these bits is the number of user data bytes transmitted to the PLC which follow.	1.0... 1.7	Bit	1 _h (00001 _b) ... FF _h (00255 _d)	0h (00000b)

10.3 Description of the output bytes (control bytes)

10.3.1 Structure and meaning of the output bytes (control bytes)

7	6	5	4	3	2	1	0	
ND	Address 4	Address 3	Address 2	Address 1	Address 0	Broadcast	Command mode	Control byte 0
				CTB	SFB		R-ACK	Control byte 1
Data byte 1								Data
Data byte 2								
...								

Table 10.2: Structure of the output bytes (control bytes)

Bits of the output byte (control byte) 0

Bit no.	Designation	Meaning
0	Command mode	Command mode
1	Broadcast	Broadcast (only relevant with a connected MA 3x)
2 ... 6	Address 0 .. 4	Address bits 0 .. 4 (only relevant with a connected MA 3x)
7	ND	New data

Bits of the output byte (control byte) 1

Bit no.	Designation	Meaning
0	R-ACK	Read-Acknowledge
2	SFB	Send data from transmit buffer
3	CTB	Copy to transmit-buffer

10.3.2 Detailed description of the bits (output byte 0)

Bit 0: Command mode: Command mode

Output data	Description	Addr.	Data type	Value range	Default
Command mode	Command mode This bit is used to activate Command mode. In Command mode, no data is sent by the PLC to the Leuze end device via the gateway. In Command mode, various bits that execute corresponding commands depending on the selected Leuze device can be set in the data- or parameter field. For further information, see chapter 11.1.3 "Command mode".	0.0	Bit	0: Default, transparent data transmission 1: Command mode	0

The following two control bits ("Bit 1: Broadcast: Broadcast" on page 49 and "Bit 2 ... 6: address bits 0 .. 4: address 0 .. 4" on page 49) are only relevant with a connected MA 3x. With other devices, these fields are ignored.

Bit 1: Broadcast: Broadcast

Output data	Description	Addr.	Data type	Value range	Default
Broadcast	Broadcast A broadcast only functions with a multiNet network connected via the MA 3x. If this bit is activated, the gateway automatically adds the broadcast command "00B" before the data. This is directed at all participants in the multiNet.	0.1	Bit	0: No broadcast 1: Broadcast	0

Bit 2 ... 6: address bits 0 .. 4: address 0 .. 4

Output data	Description	Addr.	Data type	Value range	Default
Address 0 .. 4	Address bits 0 .. 4 As with the broadcast command, individual devices in the multiNet can also be addressed via the MA 3x. In this case, the corresponding address of the device precedes the data field.telegram.	0.2 ... 0.6	Bit	00000: Addr. 0 00001: Addr. 1 00010: Addr. 2 00011: Addr. 3 ...	0

Bit 7: New data: ND

Output data	Description	Addr.	Data type	Value range	Default
ND	New data This bit is needed if several identical pieces of data are to be sent in sequence.	0.7	Bit	0->1; 1->0: On each status change for new data	0

10.3.3 Detailed description of the bits (output byte 1)

Bit 0: Read-Acknowledge: R-ACK

This bit is only relevant for writing slave data in blocks (Collective mode), see chapter .

Output data	Description	Addr.	Data type	Value range	Default
R-ACK	Read-Acknowledge (read confirmation) Toggle bit: Indicates to the fieldbus gateway that the "old" data has been processed and that new data can be received. At the end of a read cycle, this bit must be toggled in order to be able to receive the next data set. This toggle bit is switched by the master after valid received data has been read out of the input bytes and the next datablock can be requested. If the gateway detects a signal change in the R-ACK bit, the next bytes are automatically written from the receive buffer to the input data words and the BLR bit toggled. Further toggling erases the memory (to 00h).	1.0	Bit	0->1 or 1->0: Successfully written & ready for the next transmission	0

Bit 2: Send data from buffer: SFB

This bit is only relevant for writing slave data in blocks (Collective mode), see chapter .

Output data	Description	Addr.	Data type	Value range	Default
SFB	Send data from buffer (send data from the gateway transmit buffer to the RS 232) Toggle bit: changing this bit causes all data which was copied to the transmit buffer of the fieldbus gateway via the CTB bit to be transmitted to the RS 232 interface or the connected Leuze device.	1.2	Bit	0->1: Data to RS 232 1->0: Data to RS 232	0

Bit 3: Copy to transmit buffer: CTB

This bit is only relevant for writing slave data in blocks (Collective mode), see chapter .

Output data	Description	Addr.	Data type	Value range	Default
CTB	<p>Copy to transmit buffer (transmission data to transmit buffer)</p> <p>Toggle bit: Changing this bit writes the data from the PLC to the transmit buffer of the fieldbus gateway. This is used, for example, for long command strings which must be transmitted to the connected ident device.</p> <p>The CTB toggle bit is switched whenever transmit data is not to be sent directly via the serial interface, but instead transferred to the transmit buffer.</p>	1.3	Bit	<p>0->1: Data in buffer</p> <p>1->0: Data in buffer</p>	0



Notice!

The state change of the CTB bit signals the MA that the data is going into the buffer; therefore, it's essential to observe the order!

When the CTB is not used, the telegram (which fits in one cycle) is transmitted directly to the RS 232 interface. Please make sure it is complete!

10.4 Delete RESET function / memory

For many applications, it is helpful to be able to reset the MA buffer (in Collective mode) or status bits.

The following bit pattern can be transmitted from the PLC for this purpose (if >20 ms is pending):

Control byte 0: 10101010 (AAh)
 Control byte 1: 10101010 (AAh)
 OUT data byte 0/parameter byte 0: AAh
 OUT data byte 1/parameter byte 1: AAh

This sets the memory or status/control bits to 00h.

Please observe that the data image may need to be updated by toggling in Collective mode.

11 Modes

11.1 Functionality of the data exchange

The fieldbus gateway has two different modes that can be selected via the PLC:

- **Transparent mode (default setting)**
In Transparent mode, all data are sent 1:1 and directly by the serial end device to the PLC. It is not necessary to use status and control bits here. However, only data bytes possible for **one** transmission cycle are transmitted - all others are lost.
The distance between two successive telegrams (without frame) must be more than 20ms, since there is otherwise no clear separation between them.
ASCII characters are typically expected as data content; under certain circumstances, the MA therefore detects different control characters as invalid characters in the data range and truncates them. At 00_h in the data range, the MA cuts the telegram off because unnecessary bytes are also filled with 00_h.
- **Collective mode**
In Collective mode, the data of the serial end device is stored temporarily in the fieldbus gateway by toggling the CTB bit and is not sent to the PLC in blocks until prompted to do so by the PLC.
On the PLC, a status bit (DEX) then signals that new data is ready for retrieval. This data is then read out from the fieldbus gateway in blocks (toggle bit).
In order to distinguish between the individual telegrams on the PLC, in Collective mode the serial frame is sent to the PLC in addition to the data.

The size of the buffer is 1 kByte.



Notice!

In Collective mode, the CTB and SFB bits are needed for communication handling via the buffer. Telegrams that can also be completely transmitted in one cycle in Collective mode (including data frame) go directly through. If PLC data is provided and transferred without a state change of the CTB bit, it goes directly to the RS 232 interface with the set telegram data length. Incomplete (incl. data frame) or faulty telegrams can cause error messages in the connected device!

Combination with the Command mode is possible.

Data exchange in blocks must be programmed on the PLC.

11.1.1 Reading slave data in Collective mode (gateway -> PLC)

If the Leuze device transmits data to the fieldbus gateway, the data is stored temporarily in a buffer. The PLC is signaled via the "DEX" bit that data is ready for retrieval in the memory. Data is not automatically transmitted.

If no further user data is present in the MA 2xx*i* ("DEX" bit = "0"), the "R-ACK" bit must be toggled once as read confirmation to release data transmission for the next read cycle.

If the buffer still contains more data ("DEX bit = 1), the next remaining user data present in the buffer is transmitted by toggling the "R-ACK" control bit. This process is to be repeated until the "DEX" bit returns to "0"; all data has then been removed from the buffer. "R-ACK" must be toggled here again once more as a terminating read confirmation in order to release data transmission for the next read cycle.

Used status and control bits:

- DLC
- BLR
- DEX
- R-ACK

Writing slave data in Collective mode (PLC -> gateway) *Writing in blocks*

The data sent by the master to the slave is first collected in a "transmit buffer" by setting the "CTB" bit (**C**opy to **t**ransmit **b**uffer). Please observe that data provided is transmitted directly by toggling the bit.

The data is then sent in the order received from the buffer to the connected Leuze device via the serial interface with the command: "SFB" (**S**end data **f**rom transmit **b**uffer). Please don't forget the suitable data frame!

Afterward, the buffer is again empty and can be written with new data.



Notice!

With this function, it is possible to temporarily store longer data strings in the gateway independent of how many bytes the used fieldbus can transmit at once. With this function, longer PT sequences or RFID write sequences, for example, can be transmitted, since the connected devices can, in this way, receive their commands (e.g., PT or W) in a continuous string. The respective frame (STX CR LF) is needed to differentiate between the individual telegrams.

Used status and control bits:

- CTB
- SFB

11.1.2 W-ACK

If PLC data is provided and transferred without a state change of the CTB bit, it goes directly to the RS 232 interface with the set telegram data length. Incomplete (incl. data frame) or faulty telegrams can cause error messages in the connected device!

Examples for the activation of a Leuze device

In the data part (starting at byte 2) of the telegram to the gateway, a "+" (ASCII) is sent for activation.

This means that the hex value "2B" (corresponds to a "+") is to be entered in control or output byte 2. To deactivate the reading gate, a "2D" (hex) must be used instead (corresponds to a "-" ASCII).

7	6	5	4	3	2	1	0	
ND	Address 4	Address 3	Address 2	Address 1	Address 0	Broadcast	Command mode	Control byte 0
				CTB	SFB		R-ACK	Control byte 1

Data byte / parameter byte 0	
Data byte / parameter byte 1	
...	

7	6	5	4	3	2	1	0	
0	0	0	0	0	0	0	0	Output byte 0
0	0	0	0	0	0	0	0	Output byte 1
0	0	0	0	0	0	B	2	Output byte 2
0	0	0	0	0	0	0	0	Output byte 3

Collective mode sequence diagram

Send long online commands to the DEV, read RS 232 answer from DEV

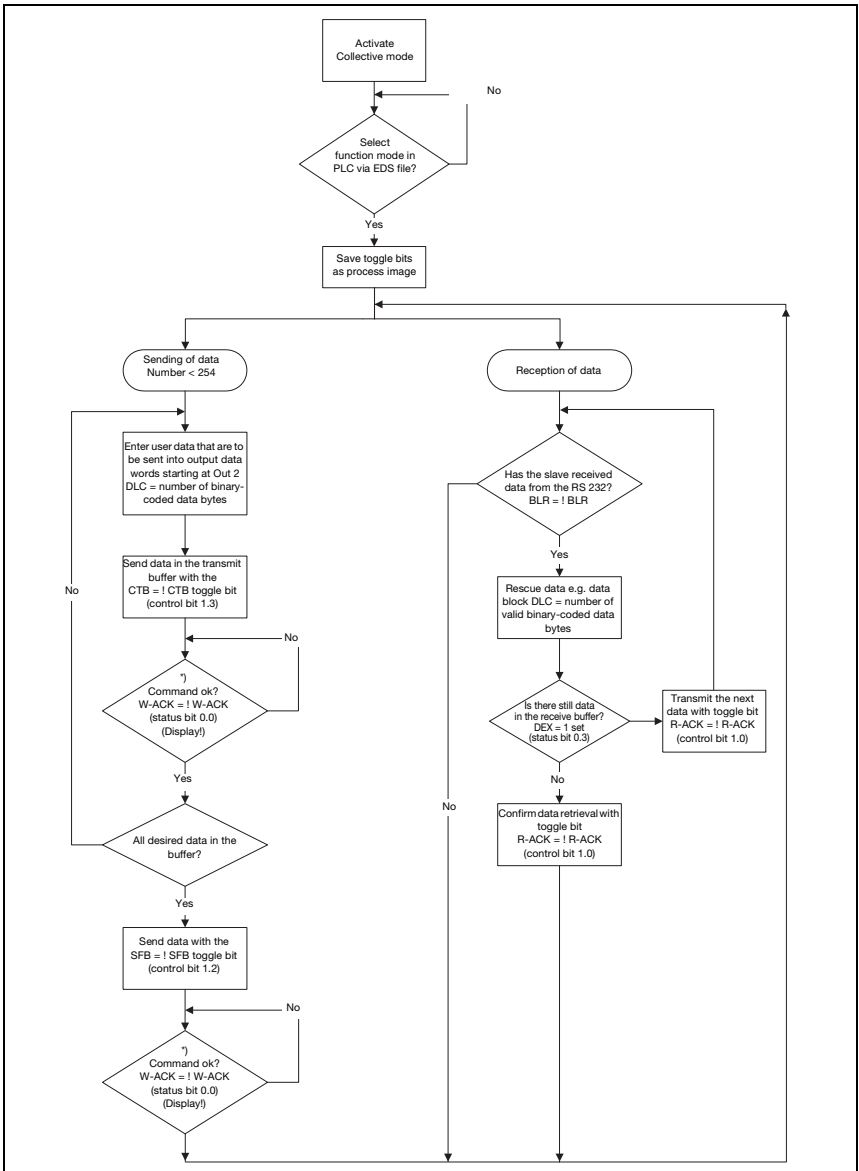

Figure 11.1: Data transmission scheme with long online commands

11.1.3 Command mode

One specific feature is the so-called Command mode, which is defined via the output control byte 0 (bit 0)... and enables the control of the connected device per bit.

If the Command mode is activated (Command mode = 1), no data is sent by the PLC to the Leuze end device via the gateway. The data from the MA to the PLC is transmitted in the selected operating mode (Transparent/Collective).

With the Command mode, it is possible to set various device-specific bits in the data- or parameter field that execute the corresponding serial commands (e.g., v, +, -, etc.). If, for example, the version of the Leuze end device is to be queried, the corresponding bit is to be set so that a "v" is sent to the Leuze device with the <STX> v <CR> <LF> frame.

The Leuze end device also answers the gateway with data (e.g. bar code content, NoRead, device version, etc.) in response to most commands. The answer is immediately passed on to the PLC by the gateway.



Notice!

The parameters available for the individual Leuze devices are listed in chapter 16. Command mode cannot be used with hand-held scanners.

Examples for the activation of a Leuze device

In Command mode, control or output byte 0.0 is to be set for activating the Command mode. Only the corresponding bit (control or output byte 2.1) then needs to be set for activating and deactivating the reading gate.

7	6	5	4	3	2	1	0	
0	0	0	0	0	0	0	1	Output byte 0
0	0	0	0	0	0	0	0	Output byte 1
0	0	0	0	0	0	1	0	Output byte 2
0	0	0	0	0	0	0	0	Output byte 3

Command mode sequence diagram

Set control byte 0, bit 0.0 to 1

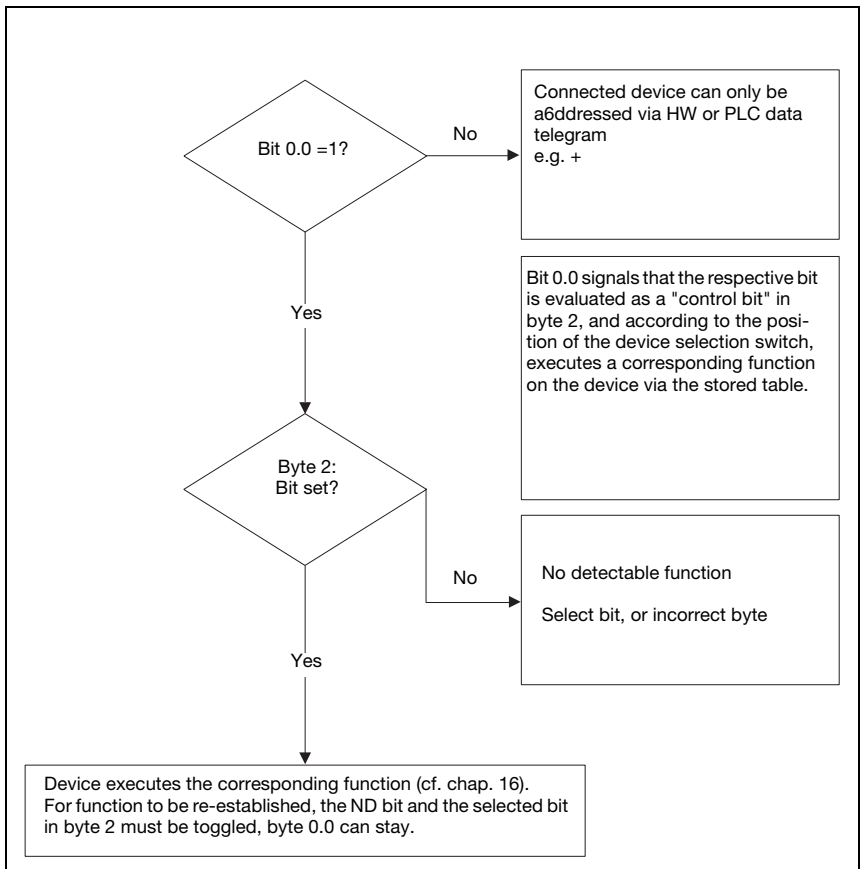

Figure 11.2: Execution of command after activation of the Command mode

Triggering the ident devices and reading the data

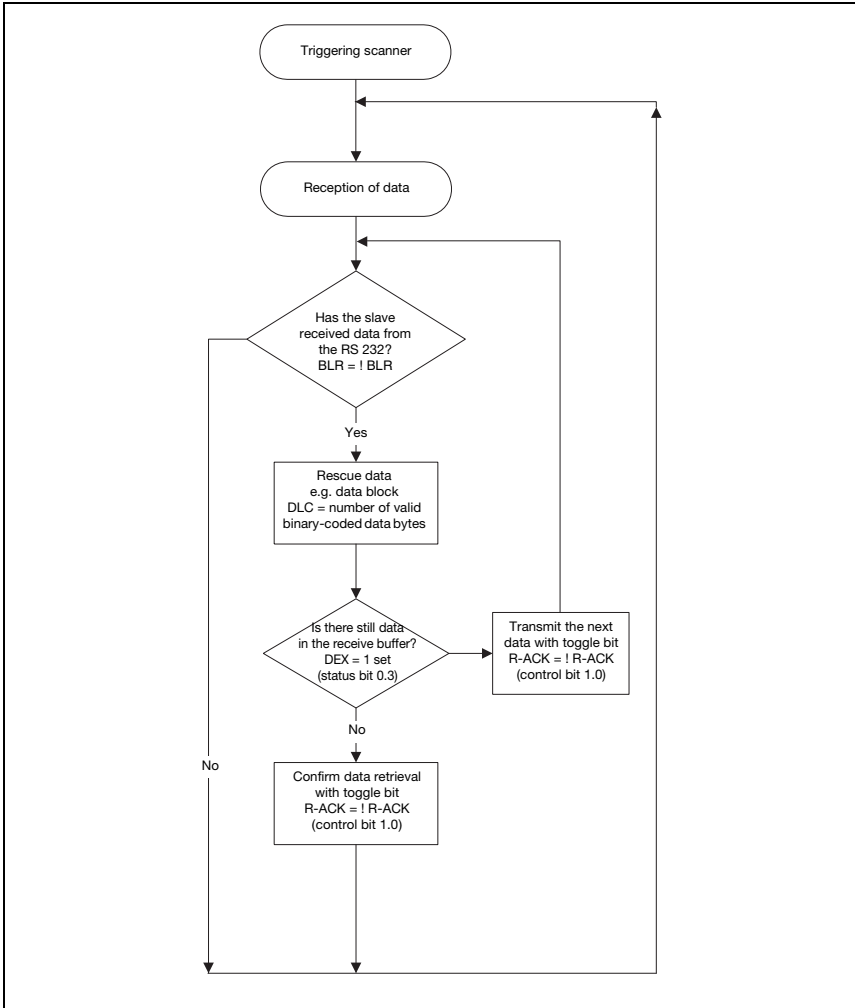

Figure 11.3: Activating DEV and reading data



Notice!

Further information on fieldbus telegram structure can be found in chapter 10.1. A specification of all usable commands can be found in chapter "Specifications for Leuze end devices" on page 81.

12 Commissioning and configuration

12.1 Measures to be performed prior to the initial commissioning

- ↳ Before commissioning, familiarize yourself with the operation and configuration of the MA 204*i*.
- ↳ **Before connecting the supply voltage**, recheck all connections and ensure that they have been properly made.

The Leuze device must be connected to the internal RS 232 device interface.

Connecting the Leuze device

- ↳ Open the housing of the MA 204*i* and guide the corresponding device cable (e.g., KB 031 for BCL 32) through the middle threaded opening.
- ↳ Connect the cable to the internal device interface (X30, X31 or X32, see chapter 7.5.1).
- ↳ Use rotary switch S4 (see chapter 8.2.5) to select the connected device.
- ↳ Now screw the PG cable gland into the threaded opening to provide strain relief and ensure protection class IP 65.

Setting the PROFIBUS device address

By setting the PROFIBUS address, the MA 204*i* is assigned its respective station number. Each network device is thereby automatically informed that it is a slave on the PROFIBUS with its specific address and that it is initialized and queried by the PLC.

The PROFIBUS permits an address range from 0 to 126. Other addresses must not be used for data communication.

- ↳ Set the station address of the gateway via the rotary switch **S1 - S3** (ones, tens and hundreds digits).

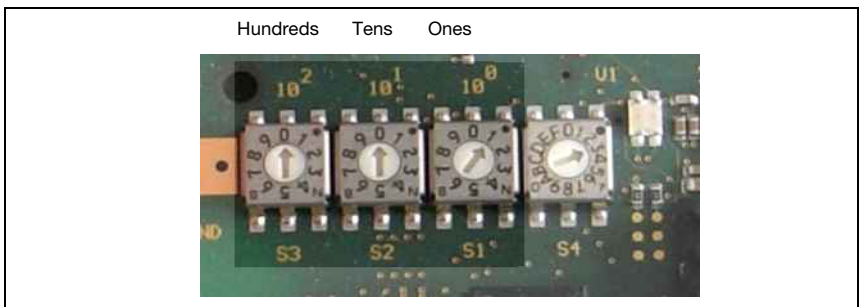

Figure 12.1: Rotary switch for setting the address

- ↳ Finally, close the housing of the MA 204*i*.

**Attention!**

Only then may the supply voltage be applied.

Upon startup of the MA 204*i*, the device selection switch and the address settings are queried and the gateway automatically sets itself to the Leuze device.

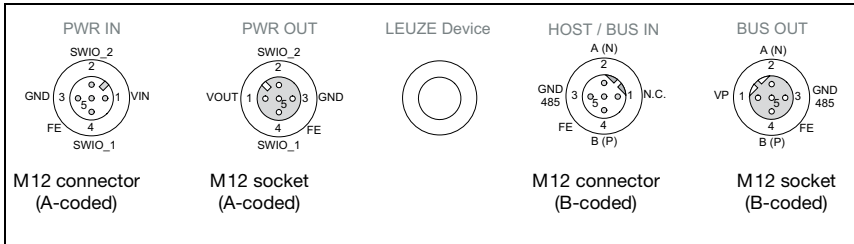

Figure 12.2: Connections of the MA 204*i* seen from below, device on mounting plate

☞ Check the applied voltage. It must be in the range between +18V ... 30VDC.

Connecting functional earth FE

☞ Ensure that the functional earth (FE) is connected correctly.

Unimpaired operation is only guaranteed when the functional earth is connected properly. All electrical disturbances (EMC couplings) are discharged via the functional earth connection.

On delivery, the SWIO 1/2 are connected in parallel on PWR IN/OUT. This connection can be separated with a jumper.

12.2 Starting the device

☞ Apply the supply voltage +18 ... 30VDC (+24VDC model); the MA 204*i* starts up.

12.3 Configuration steps for a Siemens Simatic S7 control

The following steps are necessary for commissioning with a Siemens S7 control:

1. Preparation of the control system (S7 PLC)
2. Installation of the GSD file
3. Hardware configuration of the S7 PLC
4. Configuration of the modules
5. Transmission of the PROFIBUS configuration to the controller (S7 PLC)

12.3.1 Step 1 – Preparing the control system (S7 PLC)

In the first step, the control is prepared for consistent data transmission.

During programming the control system must be prepared for consistent data transmission. This varies from control system to control system. The following possibilities are available for the Siemens control systems.

S7

The specific function blocks SFC 14 for input data and SFC 15 for output data must be integrated in the program. These are standard function blocks and are used to facilitate consistent data transmission.



Notice!

If an S7 control is used, you need to ensure that Simatic-Manager Version 5.4 + service pack 5 (V5.4+SP5) or higher is used.

12.3.2 Step 2 – Installation of the GSD file

For the subsequent configuration of the PROFIBUS devices, e.g., MA 204*i*, the corresponding GSD file must be loaded first.

General information on the GSD file

The term GSD stands for the textual description of a PROFIBUS device model.

The GSD file can support an arbitrary number of languages in one file. Every GSD file contains a version of the MA 204*i* device model. This is also reflected in the file name.

You can find the GSD file at

www.leuze.com -> Download -> identify -> Stationary and hand-held bar code readers.

All data in modules required for operating the MA 204*i* is described in this file. These are input and output data and device parameters for the functioning of the MA 204*i* and the definition of the control and status bits.

If parameters are changed, e.g., in the project tool, these changes are stored on the PLC side in the project, not in the GSD file. The GSD file is a certified and integral part of the device and must not be changed manually. The file is not changed by the system either.

The functionality of the MA 204*i* is defined via GSD parameter sets. The parameters and their functions are structured in the GSD file using module. A user-specific configuration tool is used during PLC program creation to integrate the required modules and configure them appropriately for their respective use. During operation of the MA 204*i* on the PROFIBUS DP, all parameters are set to default values. If these parameters are not changed by the user, the device functions with the default settings delivered by Leuze electronic.

For the default settings of the MA 204*i*, please refer to the following module descriptions.

12.3.3 Step 3 – Hardware configuration of the S7 PLC: Configuration

For the configuration of the PROFIBUS system using the HW Config of the SIMATIC Manager, insert the MA 204*i* into your project and assign a unique address (0 ... 125).



Notice!

Ensure that the address is the same as the address configured in the device.

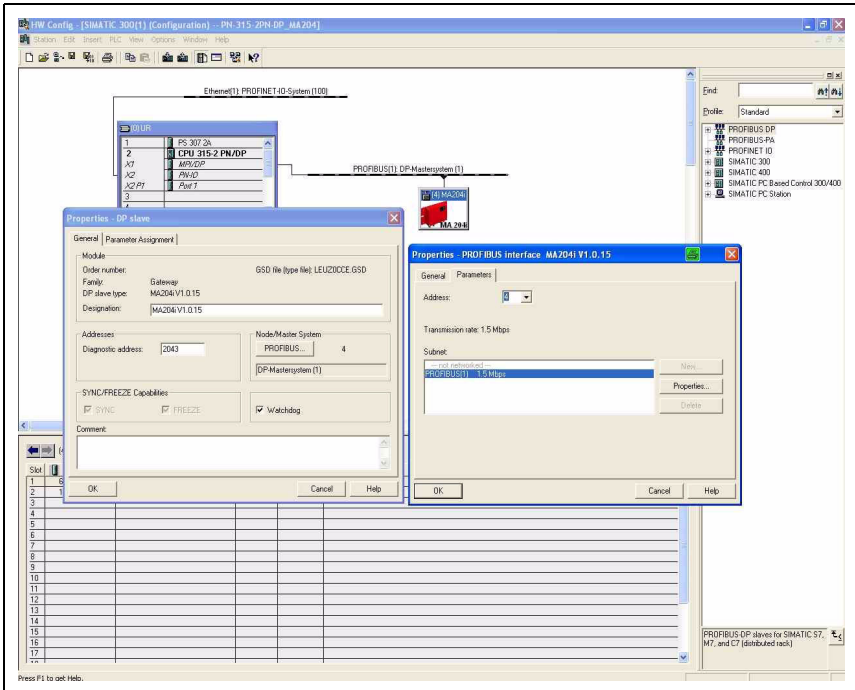



Figure 12.1: Assignment of the device address

12.3.4 Step 4 – Configuration of the modules

 Now select a corresponding data module for the input and output area.

A number of combinable modules are available with various data lengths (4, 8, 12, 16, 20, 32 ... 128 bytes). In total, a maximum of 244 bytes are possible for both the input bytes and for the output bytes.

**Notice!**

Because the data module contains 2 bytes for the control and status bytes, the actual user data length is always 2 bytes smaller than the selected data module.

E.g., when using the data module with 12 bytes, there are effectively 10 bytes available for user data on the Leuze device after subtracting the 2 bytes for status and control bytes.

Recommendation

In most cases, the 4-byte module is sufficient for the output module.

A larger module is needed, for example, if a BCL bar code scanner is to be configured by means of PT-sequences, or an RFID transponder is to be described. In these cases, larger data modules are usually sensible.

Examples of sensible settings for corresponding Leuze devices**BPS 8**

- Input module: 8 bytes
- Output module: 4 bytes

AMS

- Input module: 8 bytes
- Output module: 8 bytes

Hand-held scanner

- Input module: individual
The size of the input module is dependent on the number of digits of the bar code or 2D code that is to be read. For example, with an 12-digit bar code (+ 2 bytes of status bytes), the input module with 16 bytes is sensible.
- Output module: none
Because the hand-held scanner does not typically send any data, no output module is necessary.

BCL bar code scanners, RFID devices (RFM, RFI and RFU), LSIS 122 and LSIS 4x2i

- Input module: individual
The size of the input module is dependent on the number of digits of the bar code, RFID code or 2D code that is to be read. For example, with an 18-digit bar code (+ 2 bytes of status bytes), the input module with 20 bytes is sensible.
- Output module: 4 bytes

12.3.5 Step 5 – Transmission of the configuration to the controller (S7 PLC)

After correct transmission to the controller (S7 PLC), the PLC automatically carries out the following activities:

- Check device names
- Establishment of a connection between the controller and configured PROFIBUS devices
- Cyclical data exchange

12.4 Commissioning via the PROFIBUS DP

12.5 General information on the PROFIBUS implementation of the MA 204*i*

12.5.1 Communication profile

The **communication profile** defines how participants serially transmit their data via the transmission medium. The MA 204*i* supports the communication profile for automation systems and **Decentral Periphery** -> **PROFIBUS DP**.

DP communication profile

The **PROFIBUS DP** communication profile is designed for efficient data exchange on the field level. Data exchange with the decentral devices occurs primarily cyclically. The necessary communication functions are defined in the **DP** base functions. The **DP** optionally offers acyclic communication services as well. These are used for configuring, operating, observing and alarm handling.

In order to be able to perform data exchange, services are defined which **PROFIBUS DP** differentiates between on the basis of the data access points transmitted in the telegram header.

The MA 204*i* profile is based on the PROFIBUS profile for identification systems.

12.5.2 Bus-access protocol

The PROFIBUS communication profiles (DP,FMS) use a uniform bus-access process. It is implemented by layer 2 of the OSI model. The bus-access control (MAC) defines the process for specifying the point in time at which a network device can transmit data. It must ensure that no more than one participant has permission to transmit at any given time. The PROFIBUS bus-access process includes the token-passing process and the master-slave process.

Process	Description	MA 204 <i>i</i>
Token-passing process	With this process, the bus-access permission is distributed by means of a token. The participant obtains permission to transmit with the token. The token wanders between the master devices in the ring in a permanently defined time frame. This type of bus access is used for communication between the masters.	No
Master-slave process	Various slave devices are assigned to a master. The master can address the slaves which are assigned to it and fetch messages from them. The master always has the initiative.	Yes

Table 12.1: PROFIBUS bus-access processes

The two processes can also be mixed in order to create a multi-master system. The MA 204*i* functions both in a mono-master system as well as in a multi-master system.



Notice!

*In 2007, the PROFIBUS DP was extended by the DPV2 specification. The specification will then also permit slave-slave communication. The MA 204*i* does not support this type of communication.*

12.5.3 Device types

With the PROFIBUS DP, there are two types of master and one type of slave:

Device type	Description	MA 204 <i>i</i>
Class 1 master (DPM1)	Class 1 masters are defined for the user-data communication (e.g. PLC, PC).	
Class 2 Master (DPM2)	Class 2 masters are defined for commissioning purposes. Additional services facilitate easier configuration as well as device diagnosis.	
Slave	The slave is a peripheral device which makes available input data for the control and receives output data from the control.	X

Table 12.2: PROFIBUS DP master and slave types



Note!

*The device is defined as a slave in the device master file (GSD file) of the MA 204*i*!*

*All expanded services are **not** implemented for the MA 204*i* PROFIBUS profile.*

12.5.4 Automatic baud rate detection

The PROFIBUS implementation of the MA 204*i* features automatic baud rate detection. The MA 204*i* uses this function and offers no possibility for manual or permanent adjustment. The following baud rates are supported:

Baud rate kBit/s	9.6	19.2	45.45	93.75	187.5	500	1500	3000	6000	12000
------------------	-----	------	-------	-------	-------	-----	------	------	------	-------

Automatic baud rate detection is indicated in the device master file of the MA 204*i*:
Auto_Baud_supp = 1

12.5.5 Modular structure of the parameter

The PROFIBUS DP functionality of the device is defined via parameter sets which are clustered in modules. The modules are included in a GSD file, which is supplied as an integral part of the device. By using a user-specific project tool, such as, e.g., Simatic Manager for the Siemens programmable logic control, the required modules are integrated into a project during commissioning and its settings and parameters are adjusted accordingly. These modules are provided by the GSD file.



Notice!

All input and output modules described in this documentation are described from the controller's perspective:

- Input data arrives at the controller.
- Output data is sent out by the controller.

Detailed information on how to prepare the control and the GSD file may be found in chapter "Configuration steps for a Siemens Simatic S7 control" on page 60.

For the default settings of the MA 204*i*, please refer to the following module descriptions.



Notice!

Please note that the set data is overwritten by the PLC!

*Some controls make available a so-called "universal module". This module must not be activated for the MA 204*i*!*

From the perspective of the device, a distinction is made between PROFIBUS parameters and internal parameters. PROFIBUS parameters are all parameters that can be changed via the PROFIBUS and are described in the following modules. Internal parameters, on the other hand, can only be changed via a service interface and retain their value even following a PROFIBUS configuration.

During the configuration phase, the MA 204*i* receives parameter telegrams from the IO Controller (master). Before this is evaluated and the respective parameter values are set, all PROFIBUS parameters are reset to default values. This ensures that the parameters of modules that are not selected are set to the default values.

12.5.6 Permanently defined parameters/device parameters

On the PROFIBUS, parameters may be stored in modules or may be defined permanently in a PROFIBUS participant.

The permanently defined parameters are called "common" parameters or device-specific parameters, depending on the configuration tool.

These parameters must always be present. They are defined outside of the configuration modules and are permanently anchored in the telegram header.

In Simatic Manager, the permanently defined parameters are set via object properties of the device. The module parameters are set via the module list of the selected device. By selecting the project properties of a module, the respective parameters may be set if required.

The following list contains the device parameters that are permanently defined in the MA 204*i* (DAP Slot 0/Subslot 0) but are configurable. These parameters always exist and are available independent of the modules.

Parameter	Description	Addr.	Data type	Value range	Default	Unit
Operating mode		0:0	Bit	0:Transparent mode 1:Collective mode	0	-
Baud rate		0.1	Bit	Default, 9600	Default	
Data bits		0.2	Bit	7, 8, 9	8	
Parity		0.3	Bit	Yes, None	None	
Stop bit		0.4	Bit	0.1	1	
Use separator		0.5	Bit	Yes, No	No	
Use status and control bits		0.6	Bit	Yes, No	No	

Table 12.3: Device parameters

Parameter length: 33 byte

Input data

None

Output data

None

12.5.7 Overview of the project modules

When using PROFIBUS modules, the parameters are assembled dynamically, i.e., only the parameters that were selected by the activated modules are changed.

The MA 204*i* has parameters (device parameters) that must always be present. These parameters are defined outside of modules and are thus linked to the base module (DAP).

In the current version, several modules are available for use. A **device module (DAP)**, see Permanently defined parameters/device parameters) is used for basic scanner configuration of the MA 204*i* and is permanently integrated into the project. Further modules may be included into the project according to requirements and application.

The modules fall into the following categories:

- Parameter module for the configuration of the MA 204*i*.
- Status or control modules that influence the input/output data.
- Modules that may include both parameters and control or status information.

A PROFIBUS module defines the existence and meaning of the input and output data. In addition, it defines the necessary parameters. The arrangement of the data within a module is defined.

The composition of the input/output data is defined via the module list.

The MA 204*i* interprets the incoming output data and triggers the appropriate reactions in the MA 204*i*. The interpreter for processing the data is adapted to the module structure during initialization.

The same applies for the input data. Using the module list and the defined module properties, the input data string is formatted and referenced to the internal data.

During cyclic operation, the input data is then passed on to the controller.

During the startup or initialization phase, the MA 204*i* sets the input data to an initial value (usually 0).



Notice!

*The modules can be grouped together in any order in the engineering tool. Note, however, that many MA 204*i* modules contain related data. It is important to maintain the **consistency of these data**.*

*The MA 204*i* offers different modules. Each of these modules may only be selected once; otherwise, the MA 204*i* ignores the configuration.*

*The MA 204*i* checks its max. permissible number of modules. The control also reports an error if the input and output data across all selected modules exceed a total length of 488 bytes. A maximum of 244 bytes can be used for both the input data and for the output data. The specific limits of the individual modules of the MA 204*i* are declared in the GSD file.*

The following module overview shows the characteristics of the individual modules:

Module	Description	Input data	Output data
4 bytes input	Data content with max. 2 bytes	4	
8 bytes input	Data content with max. 6 bytes	8	
12 bytes input	Data content with max. 10 bytes	12	
16 bytes input	Data content with max. 14 bytes	16	
20 bytes input	Data content with max. 18 bytes	20	
32 bytes input	Data content with max. 30 bytes	32	
64 bytes input	Data content with max. 62 bytes	64	
128 bytes input	Data content with max. 126 bytes	128	
4 bytes output	Data content with max. 2 bytes		4
8 bytes output	Data content with max. 6 bytes		8
12 bytes output	Data content with max. 10 bytes		12
16 bytes output	Data content with max. 14 bytes		16
20 bytes output	Data content with max. 18 bytes		20
32 bytes output	Data content with max. 30 bytes		32
64 bytes output	Data content with max. 62 bytes		64
128 bytes output	Data content with max. 126 bytes		128

Table 12.4: Module overview

12.5.8 Preparing the control system for consistent data transmission

During programming the control system must be prepared for consistent data transmission. This varies from control system to control system. The following possibilities are available for the Siemens control systems.

S7

The specific function blocks SFC 14 for input data and SFC 15 for output data must be integrated in the program. These are standard function blocks and are used to facilitate consistent data transmission.



Notice!

If an S7 control is used, you need to ensure that Simatic-Manager Version 5.4 + service pack 5 (V5.4+SP5) or higher is used.

12.6 Variable configuration of the communication data width

The communication of the MA 204*i* with the fieldbus systems can be configured with a variable data width; the upper limit is restricted by the fieldbus. The following sizes are available for the data frame for PROFIBUS DP:

- 4, 8, 12, 16, 20, 24, 28, 36, 64, 128 bytes

The small data lengths (< 28 bytes) are particularly of interest for use with bar code scanners (BCL). The larger data lengths are, on the other hand, relevant for 2D code scanners (hand-held scanners, LSIS) and RFID.

Taking into consideration the maximum permissible data width of 244 bytes, multiple modules can also be used for the input data or combined with one another. The combination of module 128 and module 64, for example, yields an input data length of 192 bytes.

12.7 Setting the read parameters on the Leuze device

Commissioning the Leuze device

To commission a read station, you must prepare the Leuze device on the MA 204*i* for its reading task. Communication with the Leuze device occurs via the service interface.



Notice!

Further information on connecting and using the service interface.

↳ To do this, connect the Leuze device to the MA 204*i*.

Depending on the Leuze device, this occurs either via a connection cable (accessory no.: KB 031-1000) or directly on the MA 204*i*. The service connector and corresponding switches can be accessed with the housing cover open.

↳ Select the "DEV" service switch position.

Connect the service interface; call up the terminal program

↳ Connect your PC to the service connector via the RS 232 cable.

↳ On the PC, call up a terminal program (e.g., BCL-Config) and check whether the interface (COM 1 or COM 2) to which you have connected the MA 204*i* is set to the following Leuze standard setting: 9600 baud, 8 data bits, no parity, 1 stop bit and STX, data, CR, LF.

You can download the config. tool from www.leuze.de -> **Download** -> **Identify** for BCL, RFID, VR etc.

In order to communicate with the connected Leuze device, the **STX, data, CR, LF** framing must be set on the PC terminal program, as the Leuze device is preconfigured ex works for this frame character.

STX (02h):	Prefix 1
CR (0Dh):	Postfix 1
LF (0Ah):	Postfix 2

Operation

↳ Switch the MA 204*i* to switch position "RUN" (operation).

The Leuze device is now connected to the fieldbus. Activation of the Leuze device can now occur via the switching input on the MA 204*i*, via the process data word Out-bit 1 (Bit 0.2) or by transmitting a "+" command to the Leuze device (see chapter 16 "Specifications for Leuze end devices"). For further information on the fieldbus transmission protocol, see chapter 10 "Telegram".

Reading out information in service mode

- ↪ Set the service switch of the gateway to switch position "MA" (gateway).
- ↪ Send a "v" command to call up all service information of the MA 204*i*.

An overview of the available commands and information can be found in chapter "Reading out information in service mode" on page 41.

12.7.1 Specific feature for the use of hand-held scanners (bar code and 2D devices, combi devices with RFID)



Notice!

For a description of device configuration and the required codes, please see the corresponding documentation at www.leuze.com -> **Download** -> **identify** -> **Bar code hand-held readers** or **2D code hand-held readers**.

12.7.1.1 Cable-connected hand-held scanners on the MA 204*i*

All hand-held scanners and mobile combi devices available in the Leuze electronic product line can be used with the corresponding connection cable.

When using the MA 204*i*, the voltage supply of the hand-held scanner (5V/at 1A) can be connected to the interface by means of a cable via the 9-pin Sub-D connector (voltage on PIN 9). The corresponding cable is to be selected for the respective hand-held scanner and ordered separately. The 9-pin Sub-D cable (KB JST-HS-300, Part no. 50113397) is connected to this cable, which is connected to the MA 204*i*. This cable must also be ordered separately.

In this example, triggering occurs by means of a trigger button on the hand-held scanner.

12.7.1.2 Cableless hand-held scanners on the MA 204*i*

All cableless hand-held scanners and mobile combi devices available in the Leuze electronic product line can be used with the corresponding connection cable via the base station.

A 230VAC connection (socket) is usually necessary for the charging station. Here, a data connection of the charging station is established with the MA 204*i*. The corresponding cable is to be selected for the respective hand-held scanner and ordered separately. The 9-pin Sub-D cable (KB JST-HS-300, Part No. 50113397) is connected to this cable, which is connected to the MA 204*i*. This cable must also be ordered separately.

In this example, triggering occurs by means of a trigger button on the hand-held scanner.

The following codes for configuring the devices are necessary for these devices as well.

12.7.2 Specific features in the operation of an RFM/RFI

When using the MA 204*i* in connection with an RFID device, we recommend a data width of at least 24 bytes to be able to transmit information to or from the reader in a telegram.

Shown here is a sample telegram for a write command in combination with an RFID device.



Notice!

Also note that all characters which are sent to a transponder are hex-encoded ASCII characters. Each of these (hexadecimal) characters is, in turn, to be handled as an individual ASCII character and converted to hexadecimal format for transmission via the fieldbus.

Example:

7	6	5	4	3	2	1	0	
00	00	00	00	00	00	00	00	Control byte 0
00	00	00	00	00	00	00	00	Control byte 1
34	35	31	31	30	35	30	57	Data
00	00	34	37	33	37	35	36	

HEX	57	30	35	30	31	31	35	34	36	35	37	33	37	34
CHAR	W	0	5	0	1	1	5	4	6	5	7	3	7	4
Plain text	T e s t													

13 Diagnostics and troubleshooting

If problems should occur during commissioning of the MA 204*i* you can refer to the following table. Typical errors and their possible causes are described here as well as tips for their elimination.

13.1 General causes of errors

Error	Possible error cause	Measures
Data loss (DL bit)	Data telegram longer than the bus telegram in bus cycle/memory size.	Increase in bus telegram length. Toggle out data earlier.
Data in the RS 232 instead of in the buffer	Incorrect order.	Correct order: Provide data, toggle CTB.
PWR status LED on the circuit board		
Off	No supply voltage connected to the device.	Check supply voltage.
	Hardware error.	Send the device to customer service.
Green/orange, flashing	Device in boot mode.	No valid firmware, send device to customer service.
Continuous orange light	Device error.	Send the device to customer service.
	Firmware update failed.	
COM LED on the housing (see figure 8.1 on page 34)		
Red continuous light	Communication error on the PROFIBUS: No communication to controller established ("no data exchange").	Check interface. Cannot be rectified by a reset. Send the device to customer service.
PWR LED on the housing (see figure 8.1 on page 34)		
Off	No supply voltage connected to the device.	Check supply voltage.
	Device not yet recognized by the PROFIBUS.	Send the device to customer service.
Red continuous light	Device error.	Send the device to customer service.
Green, flashing	SERVICE active.	Service switch on RUN.
Red, flashing	Incorrect baud rate / address:	Check switch settings: Address switch S1, S2,
	Address >126: no communication	
Red continuous light	Device error.	Send the device to customer service.

Table 13.1: General causes of errors

13.2 Interface errors

Error	Possible error cause	Measures
No communication via PROFIBUS COM continuous red light LED	Incorrect wiring.	Check wiring.
	Different protocol settings.	Check protocol settings.
	Incorrect PROFIBUS address set.	Check PROFIBUS address.
Sporadic errors at the PROFIBUS	Incorrect configuration.	Check configuration of the device in the configuration tool.
	Incorrect wiring.	Check wiring. In particular, check wire shielding. Check the cable used.
	Effects due to EMC.	Check shielding (shield covering in place up to the clamping point). Check grounding concept and connection to functional earth (FE). Avoid EMC coupling caused by power cables laid parallel to device lines.
	Overall network expansion exceeded.	Check max. network expansion as a function of the max. cable lengths.

Figure 13.1: Interface error



Notice!

Please use **chapter 13 as a master copy** should servicing be required.

Cross the items in the "Measures" column which you have already examined, fill out the following address field and fax the pages together with your service contract to the fax number listed below.

Customer data (please complete)

Device type:	
Company:	
Contact partner / department:	
Phone (direct):	
Fax:	
Street / No:	
ZIP code/City:	
Country:	

Leuze Service fax number:

+49 7021 573 - 199

14 Type overview and accessories

14.1 Type key

MA 2xx i

Interface	i =	Integrated fieldbus technology
	04	PROFIBUS DP
	08	Ethernet TCP/IP
	35	CANopen
	38	EtherCAT
	48	PROFINET RT
	55	DeviceNet
	58	EtherNet/IP
MA	Modular interfacing unit	

14.2 Type overview

Type designation	Description	Description
MA 204 <i>i</i>	PROFIBUS gateway	50112893
MA 208 <i>i</i>	Ethernet TCP/IP gateway	50112892
MA 235 <i>i</i>	CANopen	50114154
MA 238 <i>i</i>	EtherCAT	50114155
MA 248 <i>i</i>	PROFINET-IO RT gateway	50112891
MA 255 <i>i</i>	DeviceNet	50114156
MA 258 <i>i</i>	EtherNet/IP	50114157

Table 14.1: Type overview MA 2xx*i*

14.3 Accessory terminating resistor

Type designation	Description	Part no.
TS 02-4-S0 M12	M12 connector with integrated terminating resistor for BUS OUT	50038539

Table 14.2: Terminating resistor for the MA 204*i*

14.4 Accessory connectors

Type designation	Description	Description
KD 02-5-BA	M12 socket for HOST or BUS IN	50038538
KD 02-5-SA	M12 connector for BUS OUT	50038537
KDS BUS OUT M12-T-5P	M12 T-connector for BUS OUT	50109834
KD 095-5A	M12 socket for voltage supply	50020501
KS 095-4A	M12 connector for SW IN/OUT	50040155

Table 14.3: Connectors for the MA 204*i*

14.5 Accessory ready-made cables for voltage supply

14.5.1 Contact assignment of PWR connection cable

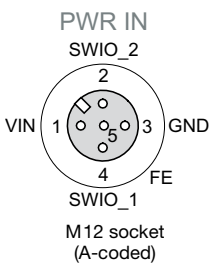
PWR IN (5-pin socket, A-coded)			
 <p>PWR IN SWIO_2 VIN 1 3 GND 4 FE SWIO_1 M12 socket (A-coded)</p>	Pin	Name	Core color
	1	VIN	brown
	2	SWIO_2	white
	3	GND	blue
	4	SWIO_1	black
	5	FE	gray
Thread	FE	bare	

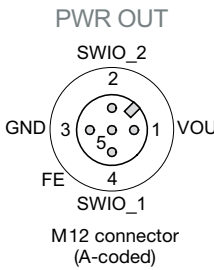
PWR OUT (5-pin connector, A-coded)			
 <p>PWR OUT SWIO_2 GND 3 1 VOUT 4 FE SWIO_1 M12 connector (A-coded)</p>	Pin	Name	Core color
	1	VOUT	brown
	2	SWIO_2	white
	3	GND	blue
	4	SWIO_1	black
	5	FE	gray
Thread	FE	bare	

14.5.2 Specifications of the cables for voltage supply

Operating temperature range	in rest state: -30°C ... +70°C
	in motion: 5°C ... +70°C
Material	sheathing: PVC
Bending radius	> 50mm

14.5.3 Order codes of the cables for voltage supply

Type designation	Description	Part no.
K-D M12A-5P-5m-PVC	M12 socket for PWR, axial plug outlet, open cable end, cable length 5 m	50104557
K-D M12A-5P-10m-PVC	M12 socket for PWR, axial plug outlet, open cable end, cable length 10 m	50104559

Table 14.4: PWR cables for the MA 204*i*

14.6 Accessory ready-made cables for bus connection

14.6.1 General information

- Cable KB PB... for connecting to the BUS IN/BUS OUT M12 connector
- Standard cable available in lengths from 2 ... 30 m
- Special cables on request

14.6.2 Contact assignment of M12-PROFIBUS connection cable KB PB...

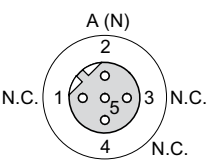
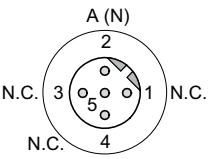
PROFIBUS connection cable (5-pin socket/connector, B-coded)			
	Pin	Name	Core color
 <p>M12 socket (B-coded)</p>	1	N.C./VCC	-
	2	A (N)	green
	3	N.C./GND 485	-
	4	B (P)	red
	5	N.C.	-
 <p>M12 connector (B-coded)</p>	Thread	FE	bare

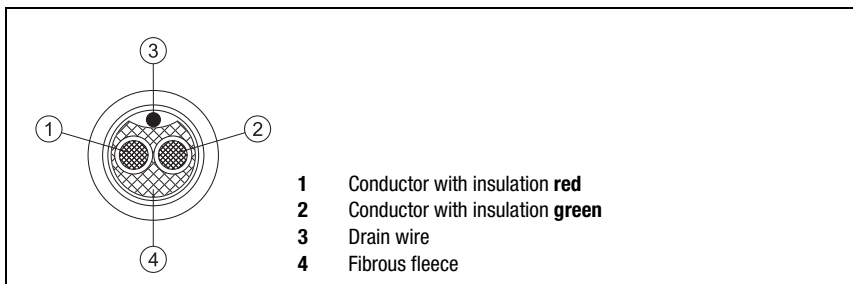

Figure 14.1: Cable structure of PROFIBUS connection cable

14.6.3 Specifications of M 12-PROFIBUS connection cable KB PB...

Operating temperature range	in rest state: -40°C ... +80°C in motion: -5°C ... +80°C
Material	The lines fulfill the PROFIBUS requirements and are free of halogens, silicone, and PVC
Bending radius	> 80mm, suitable for drag chains

14.6.4 Order codes of M 12-PROFIBUS connection cable KB PB...

Type designation	Description	Part no.
M 12 socket for BUS IN, axial connector, open cable end		
KB PB-2000-BA	Cable length 2m	50104181
KB PB-5000-BA	Cable length 5m	50104180
KB PB-10000-BA	Cable length 10m	50104179
KB PB-30000-BA	Cable length 30m	50104175
M 12 connector for BUS OUT, axial connector, open cable end		
KB PB-2000-SA	Cable length 2m	50104188
KB PB-5000-SA	Cable length 5m	50104187
KB PB-10000-SA	Cable length 10m	50104186
KB PB-30000-SA	Cable length 30m	50104182
M 12 connector + M 12 socket for PROFIBUS/multiNet plus, axial connector		
KB PB-1000-SBA	Cable length 1m	50104096
KB PB-2000-SBA	Cable length 2m	50104097
KB PB-5000-SBA	Cable length 5m	50104098
KB PB-10000-SBA	Cable length 10m	50104099
KB PB-30000-SBA	Cable length 30m	50104173

Table 14.5: Bus connection cable for the MA 204*i*

14.7 Accessory ready-made cables for connecting Leuze ident devices

14.7.1 Order codes for the device connection cables

Type designation	Description	Part no.
KB JST-3000	MA 31, BCL 90, IMRFU-1(RFU), cable length 3m	50115044
KB JST-HS-300	Hand-held scanner, cable length 0.3m	50113397
KB JST-M12A-5P-3000	BPS 8, BCL 8, cable length 3m	50113467
KB JST-M12A-8P-Y-3000	LSIS 4x2i, cable length 3m	50113468
KB JST-M12A-8P-3000	LSIS 122, cable length 3m	50111225
K-D M12A-5P-5m-PVC	Voltage supply, cable length 5m	50104557
K-D M12A-5P-10m-PVC	Voltage supply, cable length 10m	50104559
K-DS M12A-MA-5P-3m-S-PUR	ODS 96B with RS 232	50115049
K-DS M12A-MA-8P-3m-S-PUR	ODSL 30/D 232-M12	50115050
K-DS M12A-MA-5P-3m-1S-PUR	Konturflex Quattro RSX	50116791
KB AMS 1000 SA	AMS 200, cable length 1 m	50106978
KB 500-3000-Y	BCL 300i, BCL 500i, cable length 3m	50110240
KB 031 1000	BCL 32, cable length 1 m	50103621
KB 031 3000	BCL 32, cable length 3 m	50035355

Table 14.6: Device connection cables for the MA 204*i*



Notice!

The BCL 22 devices with JST connector, RFM xx and RFI xx can be connected directly with the injection molded device cable.

14.7.2 Contact assignment for the device connection cables

K-D M12A-5P-5000/10000 connection cable (5-pin with injection molded connector), open cable end													
		Pin	Core color										
	1	br/BN	<table border="1"> <tr><td>1</td><td>brown</td></tr> <tr><td>2</td><td>white</td></tr> <tr><td>3</td><td>blue</td></tr> <tr><td>4</td><td>black</td></tr> <tr><td>5</td><td>gray</td></tr> </table>	1	brown	2	white	3	blue	4	black	5	gray
	1	brown											
	2	white											
	3	blue											
	4	black											
5	gray												
2	ws/WH												
3	bl/BU												
4	sw/BK												
5	gr/GY												

KB JST 3000 (RS 232 connection cable, JST pin strip 10-pin, open cable end)		
Signal	Core color	JST 10-pin
TxD 232	red	5
RxD 232	brown	4
GND	orange	9
FE	shield	10

15 Maintenance

15.1 General maintenance information

The MA 204*i* does not require any maintenance by the operator.

15.2 Repairs, servicing

Repairs to the device must only be carried out by the manufacturer.

 *Contact your Leuze distributor or service organization should repairs be required.
The addresses can be found on the inside of the cover and on the back.*



Notice!

When sending devices to Leuze electronic for repair, please provide an accurate description of the error.

15.3 Disassembling, packing, disposing

Repacking

For later reuse, the device is to be packed so that it is protected.



Notice!

Electrical scrap is a special waste product! Observe the locally applicable regulations regarding disposal of the product.

16 Specifications for Leuze end devices

Serial interface and Command mode

The corresponding Leuze end device can be selected while configuring the fieldbus gateway (see chapter 9 "Configuration").

The exact specifications for the individual Leuze end devices can be found in the following sections and in the device description.

The corresponding serial command is sent to the Leuze end device in Command mode. To send the corresponding command to the RS 232 device after activating the Command mode in byte 0 (control bit 0.0), set the corresponding bit in byte 2.

The Leuze end device also responds to most commands by sending data, such as the bar code contents, NoRead, device version, etc., back to the gateway. The answer is not evaluated by the gateway, but is instead passed on to the PLC.

Additional parameters such as the baud rate and data mode can be configured via the GSD file with the "USE GSD settings" enable function. The data frame and, if necessary, the length are specified via the switch position. However, the changes have to match the device settings.

For the BPS 8, AMS and hand-held scanners, a number of specific features are to be noted.

16.1 Standard setting, KONTURflex (S4 switch position 0)

This switch position can be used with almost all devices, since a data frame is transmitted along with it if necessary. A 00h in the data range of the control is interpreted as the end of a telegram/invalid, however.

The distance between two successive telegrams (without frame) must be more than 20ms in this switch position, since there is otherwise no clear separation between them. If necessary, the settings have to be adjusted on the device.

Leuze measuring sensors with RS 232 interface (such as a KONTURflex Quattro RS) do not necessarily use a telegram frame, which is why these are also operated in switch position 0.

Specifications for the serial interface

Default parameter	Standard
Baud rate	9600
Data mode	8N1
Handshake	no
Protocol	framing protocol without acknowledgment
Frame	<Data>
Data mode	transparent



Notice!

The data frame is specified via the switch position. Only the data mode and the baud rate can also be set via the GSD file.

In the factory setting, the S4 switch position is 0.

KONTURflex specifications

Settings on the MA 204*i*

- PROFIBUS address is freely selectable
- Device selection switch at position "0"

Settings on the PROFIBUS

- Module selection:
Dependent on number of beams used, but at least "8 bytes in"
- User Parameters:
"Transparent mode", "Use GSD settings", baud rate 38400, "8 data bits", "No parity", "2 stop bits";

KONTURflex settings

First, the following settings are to be performed on the device using KONTURFlex-Soft:

- Either "Autosend (fast)" or "Autosend with data in Modbus format"
- Repeat time "31.5ms"
- Autosend baud rate "38.4KB"
- 2 stop bits, no parity

16.2 Bar code reader BCL 8 (S4 switch position 1)

Specifications for the serial interface

Default parameter	BCL 8
Baud rate	9600
Data mode	8N1
Handshake	no
Protocol	framing protocol without acknowledgment
Frame	<STX> <Data> <CR> <LF>

Specifications for Command mode

To activate the Command mode, bit 0 must be set to 1 in control byte 0.

For further information, see chapter 11.1.3 "Command mode", figure 11.2.

Control bit	Meaning	Corresponds to serial command (ASCII)
0	Version query	v
1	Activation / deactivation reading gate	+ / -
2	Reference-code 1 teach-in	RT1
3	Reference-code 2 teach-in	RT2
4	Automatic configuration of reading task activation / deactivation	CA+ / CA-
5	Switching output 1 activation	OA1
6		
7	Switching output 1 deactivation	OD1
8	System standby	SOS
9	System active	SON
10	Query reflector polling	AR?
11	Output version of the boot kernel with check sum	VB
12	Output version of the decoder program with check sum	VK
13	Reset parameters to default values	PC20
14	Device restart	H

Recommended settings

- Input module: dependent on the number of digits of the bar code that is to be read.

With an 18-digit bar code (+ 2 bytes of status bytes), for example, the input module with 20 bytes is sensible.

- Output module: 4 bytes

16.3 Bar code reader BCL 22 (S4 switch position 2)

Specifications for the serial interface

Default parameter	BCL 22
Baud rate	9600
Data mode	8N1
Handshake	no
Protocol	framing protocol without acknowledgment
Frame	<STX> <Data> <CR> <LF>

Specifications for Command mode

To activate the Command mode, bit 0 must be set to 1 in control byte 0.

For further information, see chapter 11.1.3 "Command mode", figure 11.2.

Control bit	Meaning	Corresponds to serial command (ASCII)
0	Version query	v
1	Activation / deactivation reading gate	+ / -
2	Reference-code 1 teach-in	RT1
3	Reference-code 2 teach-in	RT2
4	Automatic configuration of reading task activation / deactivation	CA+ / CA-
5	Switching output 1 activation	OA1
6	Switching output 2 activation	OA2
7	Switching output 1 deactivation	OD1
8	Switching output 2 deactivation	OD2
9		
10		
11	Output version of the boot kernel with check sum	VB
12	Output version of the decoder program with check sum	VK
13	Reset parameters to default values	PC20
14	Device restart	H
15		

Recommended settings

- Input module: dependent on the number of digits of the bar code that is to be read.

With an 18-digit bar code (+ 2 bytes of status bytes), for example, the input module with 20 bytes is sensible.

- Output module: 4 bytes

16.4 Bar code reader BCL 32 (S4 switch position 3)

Specifications for the serial interface

Default parameter	BCL 32
Baud rate	9600
Data mode	8N1
Handshake	no
Protocol	framing protocol without acknowledgment
Frame	<STX> <Data> <CR> <LF>

Specifications for Command mode

To activate the Command mode, bit 0 must be set to 1 in control byte 0.

For further information, see chapter 11.1.3 "Command mode", figure 11.2.

Control bit	Meaning	Corresponds to serial command (ASCII)
0	Version query	v
1	Activation / deactivation reading gate	+ / -
2	Reference code teach-in activation / deactivation	, / .
3		
4	Automatic configuration of reading task activation / deactivation	CA+ / CA-
5	Switching output 1 activation	OA1
6	Switching output 2 activation	OA2
7	Switching output 1 deactivation	OD1
8	Switching output 2 deactivation	OD2
9		
10		
11		
12		
13		
14	Reset parameters to default values	PC20
15	Device restart	H

Recommended settings

- Input module: dependent on the number of digits of the bar code that is to be read.
 With an 18-digit bar code (+ 2 bytes of status bytes), for example, the input module with 20 bytes is sensible.
- Output module: 4 bytes

16.5 Bar code reader BCL 300i, BCL 500i (S4 switch position 4)

Specifications for the serial interface

Default parameter	BCL 300i, BCL 500i
Baud rate	9600
Data mode	8N1
Handshake	no
Protocol	framing protocol without acknowledgment
Frame	<STX> <Data> <CR> <LF>

Specifications for Command mode

To activate the Command mode, bit 0 must be set to 1 in control byte 0.

For further information, see chapter 11.1.3 "Command mode", figure 11.2.

Control bit	Meaning	Corresponds to serial command (ASCII)
0	Version query	v
1	Activation / deactivation reading gate	+ / -
2	Reference code teach-in activation / deactivation	RT+ / RT-
3		
4	Autom. configuration of reading task activation / deact.	CA+ / CA-
5	Switching output 1 activation	OA1
6	Switching output 2 activation	OA2
7	Switching output 1 deactivation	OD1
8	Switching output 2 deactivation	OD2
9		
10		
11		
12		
13	Parameter - difference to default parameter set	PD20
14	Reset parameters to default values	PC20
15	Device restart	H

Recommended settings

- Input module: dependent on the number of digits of the bar code that is to be read.

With an 18-digit bar code (+ 2 bytes of status bytes), for example, the input module with 20 bytes is sensible.

- Output module: 4 bytes

16.6 Bar code reader BCL 90 (S4 switch position 5)

Specifications for the serial interface

Default parameter	BCL 90
Baud rate	9600
Data mode	8N1
Handshake	no
Protocol	framing protocol without acknowledgment
Frame	<STX> <Data> <CR> <LF>

Specifications for Command mode

To activate the Command mode, bit 0 must be set to 1 in control byte 0.

For further information, see chapter 11.1.3 "Command mode", figure 11.2.

Control bit	Meaning	Corresponds to serial command (ASCII)
0	Version query	v
1	Activation / deactivation reading gate	+ / -
2	Configuration mode	11
3	Alignment mode	12
4	Read operation	13
5		
6		
7		
8		
9		
10		
11		
12		
13		
14	Reset parameters to default values	PC20
15	Device restart	H

Recommended settings

- Input module: dependent on the number of digits of the bar code that is to be read.

With an 18-digit bar code (+ 2 bytes of status bytes), for example, the input module with 20 bytes is sensible.
- Output module: 4 bytes

16.7 LSIS 122 (S4 switch position 6)

Specifications for the serial interface

Default parameter	LSIS 122
Baud rate	9600
Data mode	8N1
Handshake	no
Protocol	framing protocol without acknowledgment
Frame	<STX> <Data> <CR> <LF>

Specifications for Command mode

To activate the Command mode, bit 0 must be set to 1 in control byte 0.

For further information, see chapter 11.1.3 "Command mode", figure 11.2.

Control bit	Meaning	Corresponds to serial command (ASCII)
0	Version query	i
1	Activation/Deactivation of reading gate: 12h/14h	<DC2> / <DC4>
2		
3		
4		
5		
6		
7		
8		
9		
10		
11		
12		
13		
14		
15		

Recommended settings

- Input module: dependent on the number of digits of the 2D code that is to be read.

With a 18-digit code (+ 2 bytes of status bytes), for example, the input module with 20 bytes is sensible.

- Output module: 4 bytes

16.8 LSIS 4x2i (S4 switch position 7)

Specifications for the serial interface

Default parameter	LSIS 4x2i
Baud rate	9600
Data mode	8N1
Handshake	no
Protocol	framing protocol without acknowledgment
Frame	<STX> <Data> <CR> <LF>

Specifications for Command mode

To activate the Command mode, bit 0 must be set to 1 in control byte 0.

For further information, see chapter 11.1.3 "Command mode", figure 11.2.

Control bit	Meaning	Corresponds to serial command (ASCII)
0	Version query	v
1	Image acquisition trigger	+
2		
3		
4		
5		
6		
7		
8		
9		
10		
11		
12		
13		
14		
15		

Recommended settings

- Input module: dependent on the number of digits of the 2D code that is to be read.

With a 18-digit code (+ 2 bytes of status bytes), for example, the input module with 20 bytes is sensible.

- Output module: 4 bytes

16.9 Hand-held scanner (S4 switch position 8)

Specifications for the serial interface

Default parameter	Hand-held scanner
Baud rate	9600
Data mode	8N1
Handshake	no
Protocol	framing protocol without acknowledgment
Frame	<Data> <CR> <LF>



Notice!

Command mode cannot be used with hand-held scanners.

Recommended settings

- Input module: dependent on the number of digits of the bar code or 2D code that is to be read.

With a 12-digit code (+ 2 bytes of status bytes), for example, the input module with 16 bytes is sensible.

- Output module: none

16.10 RFI, RFM, RFU RFID readers (S4 switch position 9)

Specifications for the serial interface

Default parameter	RFM 12,RFM 32 and RFM 62 RFI 32 RFU (via IMRFU)
Baud rate	9600
Data mode	8N1
Handshake	no
Protocol	framing protocol without acknowledgment
Frame	<STX> <Data> <CR> <LF>

Specifications for Command mode

To activate the Command mode, bit 0 must be set to 1 in control byte 0.
For further information, see chapter 11.1.3 "Command mode", figure 11.2.

Recommended settings

Control bit	Meaning	Corresponds to serial command (ASCII)
0	Version query	v
1	Activation / deactivation reading gate	+ / -
2		
3		
4		
5		
6		
7		
8		
9		
10		
11		
12		
13		
14	Reset parameters to default values	R ¹⁾
15	Device restart	H

1) Not for IMRFU/RFU

Input module: dependent on the number of digits of the RFID code that is to be read.

For example, it is advisable to use the input module/output module setting with 24 bytes during the reading of a serial number with 16 characters (+ 2 bytes of status bytes).

- Output module: 4 bytes

If data are to be written, it is advisable to use the setting with 24 bytes or 32 bytes. The RFID devices expect the telegrams / data in HEX format.

16.11 BPS 8 bar code positioning system (S4 switch position A)

Specifications for the serial interface

Default parameter	BPS 8
Baud rate	57600
Data mode	8N1
Handshake	no
Protocol	binary protocol without acknowledgment
Frame	<Data>

Specifications for Command mode

To activate the Command mode, bit 0 must be set to 1 in control byte 0.

For further information, see chapter 11.1.3 "Command mode", figure 11.2.

Control bit	Meaning	Corresponds to serial command (HEX)	
		byte 1	byte 2
0	Request diagnostic info	01	01
1	Request marker info	02	02
2	Request SLEEP mode	04	04
3	Request position info	08	08
4	Request individual measurement	10	10
5			
6			
7			
8			
9			
10			
11			
12			
13			
14			
15			

Recommended settings

- Input module: 8 bytes
- Output module: 4 bytes

In this switch position, the MA automatically sends a position request to the BPS 8 every 10ms until another command comes via the control. Automatic request only restarts when a new position request is sent by the PLC or when the MA is restarted.

16.12 AMS distance measurement device, ODSL xx optical distance sensors with RS 232 interface (S4 switch position B)



Notice!

In this switch position, 6-byte data (fixed) is always expected by the device. This is why a quick telegram sequence can be transmitted reliably even without a data frame.

AMS

Specifications for the serial interface

Default parameter	AMS
Baud rate	38400
Data mode	8N1
Handshake	no
Protocol	binary protocol without acknowledgment
Frame	<Data>

Specifications for Command mode

To activate the Command mode, bit 0 must be set to 1 in control byte 0.

For further information, see chapter 11.1.3 "Command mode", figure 11.2.

Control bit	Meaning	Corresponds to serial command (HEX)
0	Transmit individual position value = single shot	C0F131
1	Cyclically transmit position values	C0F232
2	Stop cyclical transmission	C0F333
3	Laser diode on	C0F434
4	Laser diode off	C0F535
5	Transmit single speed value	C0F636
6	Cyclically transmit speed values	C0F737
7		
8		
9		
10		
11		
12		
13		
14		
15		

Recommended settings

- Input module: 8 bytes
- Output module: 8 bytes

ODSL 9, ODSL 30 and ODSL 96B



Notice!

The default settings of the ODS serial interface have to be adjusted! Further information on configuration of the interface can be found in the technical description of the corresponding device.

Specifications for the serial interface

Default parameter	AMS
Baud rate	38400
Data mode	8N1
Handshake	no
Protocol	ASCII transmission, 5-digit measurement value
Frame	<Data>

Specifications for Command mode

Command mode cannot be used with the ODSL 9, ODSL 30 and ODSL 96B.

The ODSL 9/96B is to be operated in the "Precision" measure mode. The mode is set through the display menu via `Application -> Measure mode -> Precision`. You can find more details on this in the technical description.

16.13 Modular interfacing unit MA 3x (S4 switch position C)

Specifications for the serial interface

Default parameter	MA 3x
Baud rate	9600
Data mode	8N1
Handshake	no
Protocol	framing protocol without acknowledgment
Frame	<STX> <Data> <CR> <LF>

Specifications for Command mode

To activate the Command mode, bit 0 must be set to 1 in control byte 0.

For further information, see chapter 11.1.3 "Command mode", figure 11.2.

Control bit	Meaning	Corresponds to serial command (ASCII)
0	Version query	v
1		
2		
3		
4		
5		
6		
7		
8		
9		
10		
11		
12		
13		
14	Reset parameters to default values	PC20
15	Device restart	H

Recommended settings

- Input module: dependent on the number of digits of the code that is to be read.

With an 18-digit bar code (+ 2 bytes of status bytes + 2 bytes of slave address), for example, it is advisable to use the 24-byte setting.

- Output module: 4 bytes



Notice!

In this switch position, the address of the multiNet slave is also transmitted in the first two bytes of the data range!

17 Appendix

17.1 ASCII table

HEX	DEC	CTRL	ABB	DESIGNATION	MEANING
00	0	^@	NUL	NULL	Null
01	1	^A	SOH	START OF HEADING	Start of heading
02	2	^B	STX	START OF TEXT	Start of text characters
03	3	^C	ETX	END OF TEXT	Last character of text
04	4	^D	EOT	END OF TRANSMISSION	End of transmission
05	5	^E	ENQ	ENQUIRY	Request to transmit data
06	6	^F	ACK	ACKNOWLEDGE	Positive acknowledgment
07	7	^G	BEL	BELL	Bell signal
08	8	^H	BS	BACKSPACE	Backspace
09	9	^I	HT	HORIZONTAL TABULATOR	Horizontal tabulator
0A	10	^J	LF	LINE FEED	Line feed
0B	11	^K	VT	VERTICAL TABULATOR	Vertical tabulator
0C	12	^L	FF	FORM FEED	Form feed
0D	13	^M	CR	CARRIAGE RETURN	Carriage return
0E	14	^N	SO	SHIFT OUT	Shift out
0F	15	^O	SI	SHIFT IN	Shift in
10	16	^P	DLE	DATA LINK ESCAPE	Data link escape
11	17	^Q	DC1	DEVICE CONTROL 1 (X-ON)	Device control character 1
12	18	^R	DC2	DEVICE CONTROL 2 (TAPE)	Device control character 2
13	19	^S	DC3	DEVICE CONTROL 3 (X-OFF)	Device control character 3
14	20	^T	DC4	DEVICE CONTROL 4	Device control character 4
15	21	^U	NAK	NEGATIVE (/Tape) ACKNOWLEDGE	Negative acknowledge
16	22	^V	SYN	SYNCHRONOUS IDLE	Synchronization
17	23	^W	ETB	END OF TRANSMISSION BLOCK	End of data transmission bloc
18	24	^X	CAN	CANCEL	Invalid
19	25	^Y	EM	END OF MEDIUM	End of medium
1A	26	^Z	SUB	SUBSTITUTE	Substitution
1B	27	^[ESC	ESCAPE	Escape
1C	28	^\ ^	FS	FILE SEPARATOR	File separator
1D	29	^] ^]	GS	GROUP SEPARATOR	Group separator
1E	30	^^ ^^	RS	RECORD SEPARATOR	Record separator
1F	31	^_ ^_	US	UNIT SEPARATOR	Unit separator
20	32		SP	SPACE	Space
21	33	!	!	EXCLAMATION POINT	Exclamation point
22	34	"	"	QUOTATION MARK	Quotation mark
23	35	#	#	NUMBER SIGN	Number sign
24	36	\$	\$	DOLLAR SIGN	Dollar sign
25	37	%	%	PERCENT SIGN	Percent sign
26	38	&	&	AMPERSAND	Ampersand
27	39	'	'	APOSTROPHE	Apostrophe
28	40	((OPENING PARENTHESIS	Opening parenthesis

HEX	DEC	CTRL	ABB	DESIGNATION	MEANING
29	41)	CLOSING PARENTHESIS	Closing parenthesis
2A	42		*	ASTERISK	Asterisk
2B	43		+	PLUS	Plus sign
2C	44		,	COMMA	Comma
2D	45		-	HYPHEN (MINUS)	Hyphen (minus)
2E	46		.	PERIOD (DECIMAL)	Period (decimal)
2F	47		/	SLANT	Slant
30	48		0		
31	49		1		
32	50		2		
33	51		3		
34	52		4		
35	53		5		
36	54		6		
37	55		7		
38	56		8		
39	57		9		
3A	58		:	COLON	Colon
3B	59		;	SEMICOLON	Semicolon
3C	60		<	LESS THAN	Less than
3D	61		=	EQUALS	Equals
3E	62		>	GREATER THAN	Greater than
3F	63		?	QUESTION MARK	Question mark
40	64		@	COMMERCIAL AT	Commercial AT
41	65		A		
42	66		B		
43	67		C		
44	68		D		
45	69		E		
46	70		F		
47	71		G		
48	72		H		
49	73		I		
4A	74		J		
4B	75		K		
4C	76		L		
4D	77		M		
4E	78		N		
4F	79		O		
50	80		P		
51	81		Q		
52	82		R		
53	83		S		
54	84		T		
55	85		U		
56	86		V		
57	87		W		
58	88		X		

HEX	DEC	CTRL	ABB	DESIGNATION	MEANING
59	89		Y		
5A	90		Z		
5B	91		[OPENING BRACKET	Opening bracket
5C	92		\	REVERSE SLANT	Reverse slant
5D	93]	CLOSING BRACKET	Closing bracket
5E	94		^	CIRCUMFLEX	Circumflex
5F	95		_	UNDERSCORE	Underscore
60	96		`	GRAVE ACCENT	Grave accent
61	97		a		
62	98		b		
63	99		c		
64	100		d		
65	101		e		
66	102		f		
67	103		g		
68	104		h		
69	105		i		
6A	106		j		
6B	107		k		
6C	108		l		
6D	109		m		
6E	110		n		
6F	111		o		
70	112		p		
71	113		q		
72	114		r		
73	115		s		
74	116		t		
75	117		u		
76	118		v		
77	119		w		
78	120		x		
79	121		y		
7A	122		z		
7B	123		{	OPENING BRACE	Opening brace
7C	124			VERTICAL LINE	Vertical line
7D	125		}	CLOSING BRACE	Closing brace
7E	126		~	TILDE	Tilde
7F	127		DEL	DELETE (RUBOUT)	Delete

A

Accessories 75
 Bus connection cables 77
 Cables for Leuze ident devices 79
 Connector 75
 Voltage supply cables 76
 Areas of application for the fieldbus gateway 9
 ASCII table 96

C

Causes of errors
 General 73
 Interface 74
 Collective mode 16, 52
 Command mode 16, 56
 Commissioning 59
 Configuration 41, 59
 Connecting the Leuze device 12
 PCB connectors X30 ... X32 38
 Connections
 PWR IN 28
 PWR OUT switching input/output 30
 Control bytes 48

D

Declaration of conformity 6
 Definition of Terms 8
 Description of functions 7
 Device description 16
 Device interface RS 232 32
 Diagnostics 73
 Dimensioned drawings 22
 Disassembling 80
 Disposing 80

E

Electrical connection 11
 Connecting the Leuze device 12
 Power supply and bus cable 13
 Safety notices 27

F

Fast commissioning 11
 Fieldbus systems 19

I

Input byte 0
 Buffer overflow 47
 Data exist 46
 Data loss 47
 New data 48
 Next block ready to transmit 47
 Service mode active 46
 Write-Acknowledge 46
 Input byte 1
 Data length code 48
 Intended use 9
 Interface
 PROFIBUS 32

L

LED status indicators 34
 Leuze device
 2D code reader
 LSIS 122 88
 LSIS 4x2i 89
 Bar code positioning system (BPS)
 BPS 8 92
 Bar code reader (BCL)
 BCL 22 84
 BCL 300i 86
 BCL 32 85
 BCL 500i 86
 BCL 8 83
 BCL 90 87
 Distance measurement device
 AMS 93
 Hand-held scanner 90
 RFID read-write devices (RFM/RFI ...)
 RFM 12, 32 and 62 91
 Setting the read parameters 70
 Specific feature for hand-held scanners 71
 Specifications for Command mode ... 81
 Specifications for the serial interface ... 81

M

Maintenance 80
 Mounting
 Device arrangement, selecting a mounting location 11, 26
 Mounting the device 11, 25

O

Operating modes	
Operation	18
Service fieldbus gateway	18
Service Leuze device	18
Output byte 0	
Address bits 0 .. 4	49
Broadcast	49
Command mode	49
New data	49
Output byte 1	
Copy to transmit buffer	51
Read-Acknowledge	50
Send data from buffer	50

P

Packing	80
PROFIBUS DP	19

Q

Quality assurance	6
-------------------	---

R

Reading slave data	52
Repair	9, 80

S

Safety notices	9
Service interface	33, 38
Service mode	
Commands	42
Information	42
Service switch	38
Servicing	80
Setting the DeviceNet device address	12
Specifications	21
Electrical data	21
Environmental data	21
Indicators	21
Mechanical data	21
Starting the device	13, 60
Status bytes	45
Structure of the fieldbus telegram	44
Symbols	6

T

Telegram structure	
Input bytes	45
Output bytes	48
Transparent mode	16, 52
Troubleshooting	73
Type overview	23, 75

W

Writing slave data	53
--------------------	----