

KRTM 20

High Resolution Multicolor Contrast Scanner

en 01-2011/06 50116669

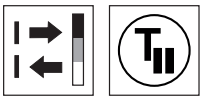

**12mm
20mm
50mm**



- **Dynamic** teach-in
- RGB transmitter
- Response time analog/digital (10µs/10µs or 10µs/20µs)
- Digital switching frequency 50kHz or 25kHz
- Resolution of 70 gray levels at the digital output
- Resolution of 400 gray levels at the analog output
- Analog output 1 ... 10mA
- Changeover to the switching threshold
- Changeover to the analysis depth
- L/D switching
- Pulse stretching



Accessories:

(available separately)

- M12 connectors, 5-pin (KD ...)
- Ready-made cables (K-D ...)
- Interchangeable objectives
- Tool for changing objectives

Dimensioned drawing

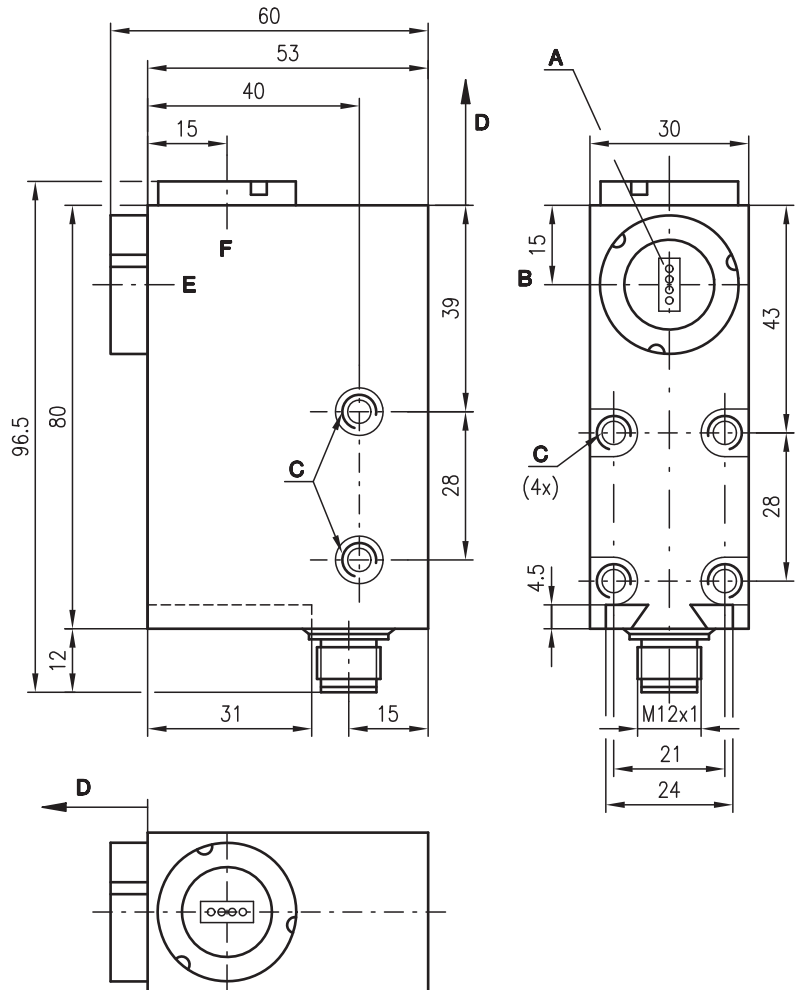

- A** Light spot orientation vertical
- B** Optical axis
- C** M5/5.5mm deep
- D** Scanning range
- E** Front
- F** Head

Electrical connection

PNP + analog

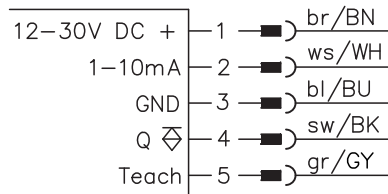

NPN + analog

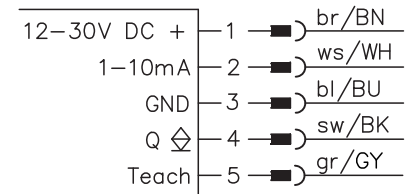

PNP

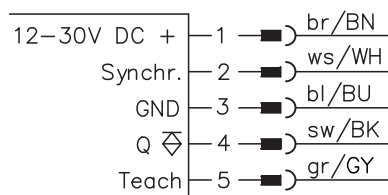

NPN

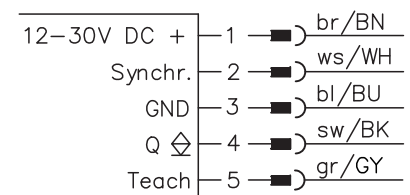

We reserve the right to make changes • DS_KRTM20M_hr_Tdyn_en.fm

Specifications

Optical data

Scanning range with objective 1 ¹⁾	12 mm ± 1 mm
Scanning range with objective 2 ²⁾	20 mm ± 2 mm
Scanning range with objective 3 ¹⁾	50 mm ± 5 mm
Light spot dimension with objective 1 ¹⁾	3.0mmx1.0mm or round light spot D = 0.5mm
Light spot dimension with objective 2 ²⁾	4.0mmx1.2mm or round light spot D = 0.6mm
Light spot dimension with objective 3 ¹⁾	10.0mmx2.0mm or round light spot D = 1.0mm
Light spot orientation	vertical or horizontal
Light source	LEDs (red, green, blue)

Timing

Switching frequency digital output	25 kHz/50 kHz reversible (see remarks)
Response time digital output	20 µs/10 µs reversible (see remarks)
Response jitter digital output	10 µs
Response time of analogue output	10 µs
Delay before start-up	≤ 250 ms

Electrical data

Operating voltage U_B	12 ... 30 VDC (incl. residual ripple)
Residual ripple	≤ 15% of U_B
Switching output	PNP, NPN
Function characteristics	light or dark switching, reversible via button
Analogue output	1 ... 10 mA
Signal voltage high/low	≥ ($U_B - 2V$) / ≤ 2V
Output current	max. 100 mA
Open-circuit current	≤ 60 mA

Indicators

After power-on:	
ON LED on	device set to factory settings
ON LED flashing slowly	device not set to factory settings (display only for approx. 10s after power-on)

After teach-in:

ON LED on	switching threshold set to factory settings
ON LED flashing slowly	-> switching threshold in center switching threshold was reconfigured -> switching threshold close to the mark teaching error

Q/T LED flashing quickly

In run mode:	
ON LED on	ready
Delay LED	pulse stretching on/off
L/D LED	light/dark switching
Q/T LED on	mark detected
Q/T LED flashing quickly	device error
In configuration mode:	
ON LED flashing quickly	device is in configuration mode
Delay LED off	2x analysis depth (response time 20 µs)
Delay LED on	1x analysis depth (response time 10 µs)
L/D LED off	switching threshold in center
L/D LED on	switching threshold close to the mark

Mechanical data

Housing	diecast zinc
Optics cover	glass
Weight	300 g
Connection type	M12 connector, stainless steel, 5-pin

Environmental data

Ambient temp. (operation/storage)	-25 °C ... +60 °C / -40 °C ... +70 °C
Protection class	IP 67
LED class	1 (acc. to EN 60825-1)
VDE safety class	II
Protective circuit ³⁾	2, 3
Standards applied	IEC 60947-5-2

Options

Synchronous input

PNP: Stop/Start measurement	$U_B/0V$ or not connected
NPN: Stop/Start measurement	$0V/U_B$ or not connected
Synchronization delay	≤ 0.5 ms

Teach input

PNP: active / not active	$U_B/0V$ or not connected
NPN: active/not active	$0V/U_B$ or not connected
Teach delay	≤ 10 ms

Pulse stretching

20ms, can be activated via button

continue to press the teach button during power-on

Changeover switching threshold

see remarks

Changeover response time

see remarks

1) Interchangeable objective, available as accessory

2) Standard objective, state on delivery

3) 2=polarity reversal protection, 3=short-circuit protection for all outputs

Remarks

- **Approved purpose:**
This product may only be used by qualified personnel and must only be used for the approved purpose. This sensor is not a safety sensor and is not to be used for the protection of persons.

- With shiny objects, the sensor is to be mounted at an angle to the object surface.

● Device configuration:

1. Configuration mode is activated by holding down the teach button during power-on (ON LED flashes).
2. The analysis depth is changed over using the Delay button:
Delay LED off =
2x analysis depth
(response time 20µs)
Delay LED on =
1x analysis depth
(response time 10µs)
3. The switching threshold is changed over using the L/D button:
L/D LED off=
Switching threshold in center
L/D LED on=
Switching threshold close to the mark
4. Press the teach button to end device configuration.
5. Back to factory settings: Simultaneously hold down the Delay button and the L/D button during power-on to reset the sensor to factory settings.

Order guide

See section **Preferred types**

KRTM 20

High Resolution Multicolor Contrast Scanner

Function principle of the contrast scanner

These contrast scanners are devices that can, with the aid of multiple transmitter colors (red, green, blue), distinguish between minimal gray levels (contrasts). By means of the automatic transmitter selection after a teach-in, the optimum functional safety for the respective contrast is determined and set by the device itself. As a result, any combination of marks or backgrounds can be detected with optimum functional safety. Through constant measurement and regulation of the emitted light, the devices operate with very good temperature stability. Re-teaching of the mark is, thus, no longer necessary.

Each transmitter color consists of 4 LEDs. A longish light spot with four points is formed in the focal point. This very small, extremely bright light spot guarantees a high repeatability and positioning accuracy. For the case that the mark or background is not optimally printed, the light spot can be focused by slightly changing the scanning distance in such a way that a homogeneous, rectangular light spot is formed.

With this teaching type, background and mark must be placed statically below the light spot. Using the synchronization input, the switching output can be activated or deactivated.

Controls and indicators

- ON LED on ready / run mode
- ON LED flashing slowly device is not set to factory settings
(Display only for approx. 10s after power-on)
- ON LED flashing quickly device is in configuration mode

- Run mode:**
Delay LED pulse stretching on /off
- Configuration mode:**
Delay LED off 2x analysis depth (response time 20µs)
- Delay LED on 1x analysis depth (response time 10µs)

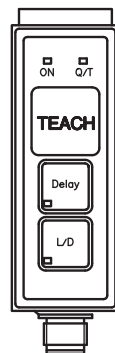

- Q/T LED on mark detected
- Q/T LED flashing quickly teach error or device error

- Run mode:**
L/D LED light/dark switching
- Configuration mode:**
L/D LED off switching threshold in center
- L/D LED on switching threshold close to the mark

Signal response during teach-in

Dynamic 2-point teach

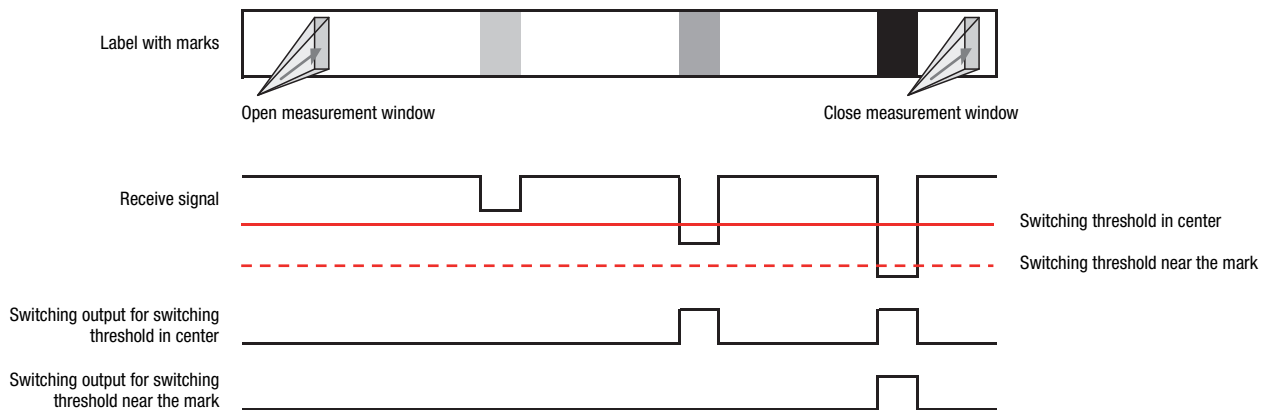

Teach process

The teach process is performed with the aid of the teach button or external teach lines. The two processes work in the same way.

Operation	Transmitter	Indicator LED
Position the light spot on the background	Red, green or blue light spot visible	
Press the teach button approx. 0.5s or set the teach line to high level	All colors are on White light spot visible	Q/T, Delay and L/D LEDs flash
Advance paper sheet for at least one pattern length	All colors are on White light spot visible	Q/T, Delay and L/D LEDs flash
Briefly press teach button or teach line to low level	Changeover to red, green or blue Red, green or blue light spot visible	ON LED on or flashes 3x Q/T LED on Q/T LED flashing -> error
Teaching error start new teaching process	All colors off	ON LED on Q/T LED flashing -> error

Calibration - analog output 1 ... 10mA

This is an uncalibrated measurement value. The current value that is output is proportional to the last contrast ascertained by means of teach-in.

For rough calibration of the analog output, a teach-in with the following sequence is recommended .

1. **Teach point on background** -> on white paper.
2. **Teach point on mark** -> without object (into open space).

Preferred types

Selection table		Order code →	KRTM 20M/P-12-6420-S12 Part No. 50116474								
Equipment ↓											
Scanning range	12mm	●									
	20mm										
	50mm										
Light spot orientation	vertical	●									
	horizontal										
	round										
Optical outlet	front										
	head	●									
Output wiring	PNP	●									
	NPN										
	analogue current										
Other features	static teach-in										
	dynamic teach-in	●									
	synchronous input	●									

Additional types on request