

ODSL 30 Ex

Optical laser distance sensors

en 02-2013/10 50122342



Dimensioned drawing

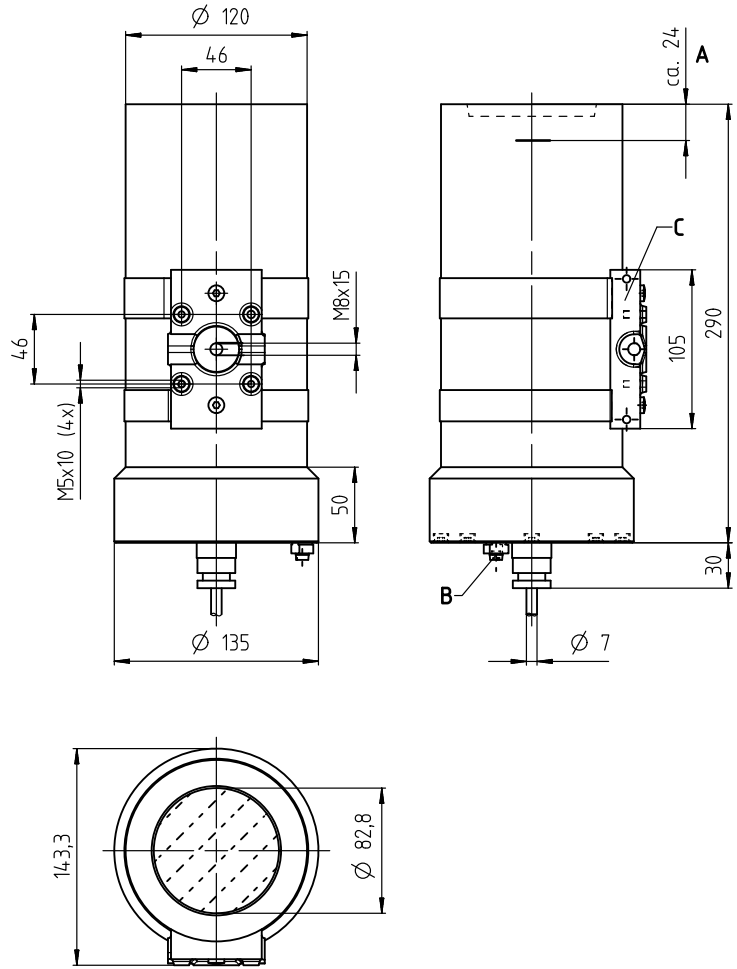

- A** Reference level for the measurement (distance zero point)
- B** Earthing
- C** Mounting foot

0.2 ... 30m

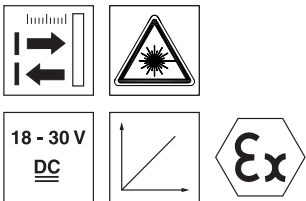

- Reflection-independent distance information
- High accuracy through referencing
- Analogue current and voltage output
- 1 teachable analogue and switching output
- Configuration via LC display and key pad (the sensor must be removed from the Ex housing for this purpose)
- EC type examination PTB 03 ATEX 1026
- Ex II 2G Ex d IIA T3
- Ex II 2D Ex td A21 IP 65 T80°C
- Ex op is IIA T3 according to TÜV report 71386471
- Cable 15m, 8-wire

Electrical connection

18–30V DC +	ws/WH
activ/reference	br/BN
GND	gn/GN
Q1 ● ○ ⊗	ge/YE
teach Q1	gr/GY
4–20mA	rs/PK
1–10V	bl/BU
AGND	rt/RD

Accessories:

(available separately)

- Co-operative Target CTS 100x100 (reflectivity 50 ... 90%)

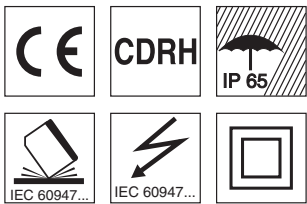

We reserve the right to make changes • DS_ODSL30V30MExd_en_50122342.fm

Specifications

Optical data

Measurement range ¹⁾	0.2 ... 30m (18 ... 90% diffuse reflection) 0.2 ... 20m (6 ... 90% diffuse reflection) 0.1mm/1mm (factory setting)
Resolution ²⁾	
Light source	laser
Wavelength	650nm
Max. output power	4mW
Pulse duration	267ns
Light spot	divergent, Ø 6mm at 10m

Error limits for current output, relative to measurement range end value ³⁾

Absolute measurement accuracy ¹⁾	measurement range up to 2.5m: ± 2% without referencing, ± 1% with referencing measurement range 2.5m up to 5m: ± 1.5% without referencing, ± 1% with referencing measurement range 5m up to 30m: ± 1% without referencing, ± 1% with referencing ± 0.5% of measurement value
Repeatability ⁴⁾	6mm (owing to glass pane)
Systematic measurement error	typ. 0.5mm/°C (without referencing)
Temperature drift	

Timing

Measurement time ⁵⁾	30 ... 100ms (factory setting: 100ms)
Delay before start-up	≤ 1s

Electrical data

Operating voltage U_B	18 ... 30VDC (incl. residual ripple)
Residual ripple	≤ 15% of U_B
Power consumption	≤ 4W
Switching output	PNP transistor, HIGH active (default), NPN transistor or push-pull through configuration
Signal voltage high/low	≥ ($U_B - 2V$) / ≤ 2V
Analog output	$R_L \geq 2k\Omega$ (voltage) $R_L \leq 500\Omega$ (current)

Indicators

Green LED	continuous light off	ready no voltage
Yellow LED	continuous light off	object inside teach-in measurement distance object outside teach-in measurement distance

Mechanical data

Housing	metal
Optics cover	glass
Weight	approx. 6500g
Connection type	cable 15m, 8-wire

Environmental data

Ambient temp. (operation/storage)	-10°C ... +45°C / -40°C ... +70°C
Protective circuit ⁶⁾	2, 3
VDE safety class ⁷⁾	II, all-insulated
Protection class	IP 65
Laser class	2 (in accordance with EN 60825-1)
Standards applied	IEC 60947-5-2

- 1) Temperature range 0°C ... +45°C
- 2) Display and output resolution 0.1mm configurable
- 3) In temperature range from 0°C to +45°C, measurement object $\geq 50 \times 50 \text{mm}^2$, with factory settings; different error limits apply at temperatures $< 0^\circ\text{C}$
- 4) Same object, identical environmental conditions
- 5) Configurable, depends on the reflectivity of the object and on the max. detection range
- 6) 2=polarity reversal protection, 3=short circuit protection for all outputs
- 7) Rating voltage 250VAC

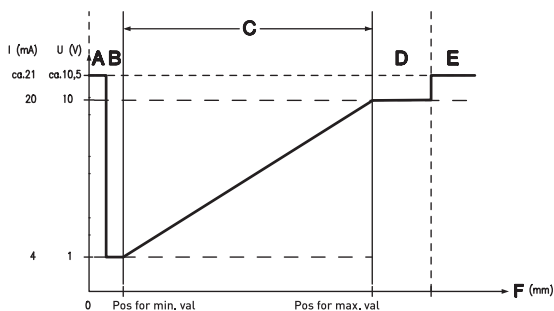

Order guide

	Designation	Part no.
with connection cable 15m, 8-wire	ODSL 30/V-30M Ex d	50122319

Remarks

- **Analog output:**
The analog output is factory-set to 200 to 5000mm with calibrated current output. To adapt the configuration, the sensor must be removed from the Ex housing.
- **Teaching procedure (factory setting):**
Position the measurement object at the desired measurement distance. Apply $+U_B$ to the teach input. Take teach input back to GND, switching output has now been taught. Edge on line **teach Q1** teaches output Q1. During the teaching of Q1, yellow LED Q1 will flash.
- **Activation/referencing input:**
Referencing is carried out by applying the voltage (for a duration of about 300ms). If this process is activated before the measurement, the highest possible accuracy is achieved.
- **Laser warning signs:**
It is important to attach the stick-on labels delivered with the device! If the signs could be covered due to the installation location of the device, attach them close to the device so that it is not possible to look into the laser beam when reading the notices.
- **Approved purpose:**
This product may only be used by qualified personnel and must only be used for the approved purpose. This sensor is not a safety sensor and is not to be used for the protection of persons.

Notices for the safe use of sensors in potentially explosive areas

Intended application range

The distance sensors of the ODSL 30 Ex d series, without making contact, detect objects which are located in or move through the light beam and measure the distance to these objects.

Validity

The sensors have an encapsulated, pressure-proof housing and can be used in the following areas with these classifications:

Device group	Device category	Equipment protection level	Zone
II	2G	Gb	Zone 1
II	2D	Db	Zone 21



Attention!

- Check whether the equipment classification corresponds to the requirements of the application.
- The devices are not suited for the protection of persons and may not be used for emergency shutdown purposes.
- A safe operation is only possible if the equipment is used properly and for its intended purpose.
- Electrical equipment may endanger humans and (where applicable) animal health, and may threaten the safety of goods if used incorrectly or under unfavorable conditions in potentially explosive areas.
- The applicable national regulations (e.g. EN 60079-14) for the configuration and installation of explosion-proof systems must be observed

Installation, Commissioning



Attention!

- Electrical equipment may endanger humans and (where applicable) animal health, and may threaten the safety of goods if used incorrectly and under unfavorable conditions in potentially explosive areas.
- A safe operation in potentially explosive areas is only possible if the equipment is used properly and for its intended purpose.
- The distance sensors of type ODSL 30 Ex d must only be installed and maintained by trained electricians.
- When installing the sensors in Ex zones 1 and 21, the connection cable must be connected in a connection space with increased safety Ex e, or outside the Ex area.
- The housing must be connected at the marked external connection unit to the protective conductor system.
- The respective applicable national regulations for the installation of electrical equipment in potentially explosive areas must be observed.

Maintenance

No changes may be made to the devices of type ODSL 30 Ex d for potentially explosive areas.

Repairs to the sensors may only be performed by persons trained for such work or by the manufacturer. Defective devices must be replaced immediately.

The housing must not be opened while the power is on! After switching off power, wait at least 10min. before opening the housing.

Cyclical maintenance of the sensors is not necessary.

Depending on the environmental conditions, it may occasionally be necessary to clean the light-emission surfaces of the sensors. This cleaning must only be performed by persons trained for performing this task. A soft, damp cloth should be used for this purpose. Cleaning agents that contain solvents must not be used.

Chemical resistance

The sensors of type ODSL 30 Ex d demonstrate good resistance against many diluted acids and bases.

Exposure to organic solvents is possible only under certain circumstances and only for short periods of time.

Resistance to chemicals should be examined on a case by case basis.

Erklärung der Konformität
Declaration of Conformity
Attestation de conformité

BARTEC

BARTEC GmbH
Max-Eyth-Straße 16
97980 Bad Mergentheim
Germany



Nº 01-6100-7C0001



Wir	We	Nous
BARTEC GmbH,		
erklären in alleiniger Verantwortung, dass das Produkt	declare under our sole responsibility that the product	attestons sous notre seule responsabilité que le produit
Steuer-, Regel- und Anzeigegerät	control, regulating and display devices	commande, de régulation et d'attache

Typenbezeichnung : Typ 07-61-2..../....

auf das sich diese Erklärung bezieht den Anforderungen der folgenden Richtlinien (RL) entspricht	to which this declaration relates is in accordance with the provision of the following directives (D)	se référant à cette attestation correspond aux dispositions des directives (D) suivantes
ATEX-Richtlinie 94/9/EG	ATEX-Directive 94/9/EC	ATEX-Directive 94/9/CE
EMV-Richtlinie 2004/108/EG	EMC-Directive 2004/108/EC	CEM-Directive 2004/108/CE
und mit folgenden Normen oder normativen Dokumenten übereinstimmt	and is in conformity with the following standards or other normative documents	et est conforme aux normes ou documents normatifs ci-dessous
EN 60079-0:2006 EN 60079-1 :2007 EN 60079-7 :2007 EN 60079-11 :2007	EN 61241-0:2006 EN 61241-1:2004 EN 61241-11:2006 EN 60529:1991 + A1:2000	EN 60439-1:1999 +A1:2004 EN 62208:2003 EN 60445:2007

Kennzeichnung	Marking	Marquage
<p> II 2G Ex de [ia/ib]IIC T6, T5,T4</p> <p> II 2D Ex tD [iaD/ibD] A21 IP66 T 80°C bzw. 95°C (abhängig von den eingebauten Komponenten; siehe Betriebsanleitung)</p>	<p>(addicted on the inserted components; see user manual)</p>	<p>(dépendant des composants intégrés; voir la notice d'utilisation)</p>
<p>Verfahren der EG-Baumusterprüfung</p> <p>PTB 03 ATEX 1051</p> <p>CE 0044</p>	<p>Procedure of EC-Type Examination</p>	<p>Procédure d'examen CE de type</p>

Bad Mergentheim, den 09.03.2010

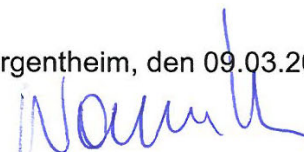

ppa. Ewald Warmuth
Geschäftsleitung / General Manager