

30'000 mm

- ✓ M18 short housing
- ✓ IO-Link
- ✓ Sensitivity adjustment via IO-Link
- ✓ Calibrated range
- ✓ Emitting sequence selection via IO-Link

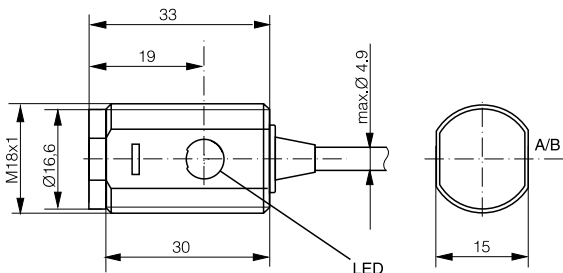

A: emitter axis B: receiver axis

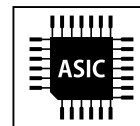
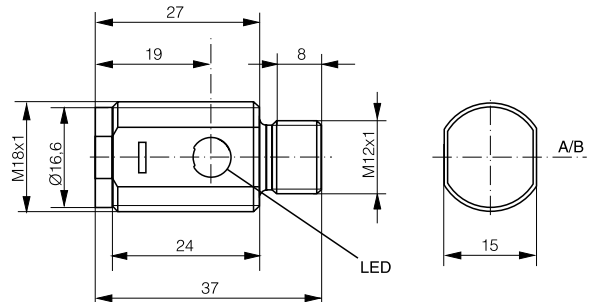

A: emitter axis B: receiver axis

OPTICAL DATA		INTERFACE	
Sensing range typ. max.	0...30'000 mm	Sensitivity adjustment	7'000...30'000 mm, IO-Link
Operating range	0...25'000 mm	Indicator LED, green	Excess gain
Light source	LED, red 630 nm	Indicator LED, yellow	Sensing state
Light spot size (distance)	Ø 35 mm (500 mm)/Ø 250 mm (6 m)/ Ø 1'000 mm (25 m)	IO-Link	✓

ELECTRICAL DATA		MECHANICAL DATA	
Supply voltage range (U _b)	10...30 VDC	Enclosure rating	IP67
Residual ripple	≤ 10% V _{pp}	Ambient temperature operation	-25...+65°C
Output current	≤ 200 mA	Shock and vibration	IEC 60947-5-2
Signal PNP high/low	≤ (U _b -2.0 V)/approx. 0 V	Weight (connector version)	6 g
Signal NPN high/low	Approx. U _b /≤ 2.0 V	Weight (cable version)	71 g
Power consumption (no load)	≤ 7 mA (emitter)/≤ 13 mA (receiver)	Housing material	ABS
Response time ¹	≤ 500 μs (normal)/≤ 1 ms/≤ 250 μs	Window material	PMMA
Switching frequency ¹	≤ 1 kHz (normal)/≤ 500 Hz/≤ 2 kHz	Connection cable	PVC, 2 m, 3-wire or 4-wire
Short circuit protection	✓	Connector type	M12 4-pin
Voltage reversal protection	✓		

¹By default, "Normal" mode. "Fine" and "Fast" modes selectable via IO-Link.

EXCESS GAIN

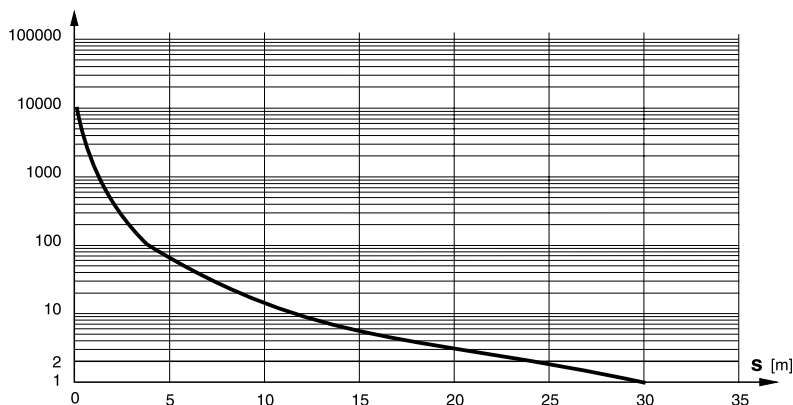

IO-LINK FUNCTIONALITIES

IO-Link version	1.0
SIO mode	Supported
Process data	Detection state & stability alarm
Baudrate	COM2 (38.4 kBaud)
Special functions	Output configuration, output timing, sensitivity, sequence choice, sensor mode, detection counter, event flags, maximum and actual sensor temperature

IO-Link specifications and IODD files may be downloaded from www.contrinex.com (Download section)

STABILITY ALARM OUTPUT (A2)

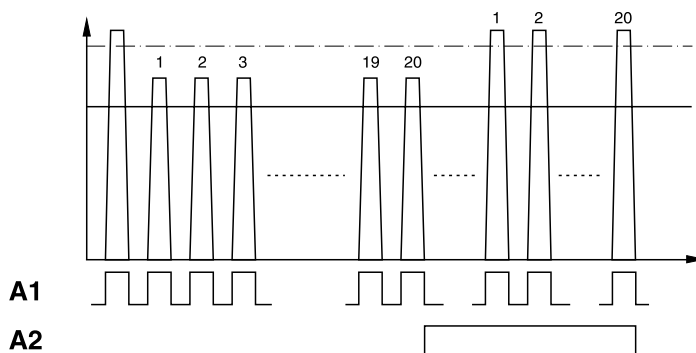

WIRING DIAGRAM

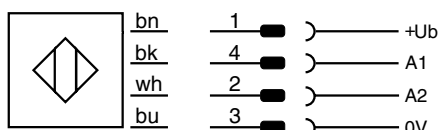
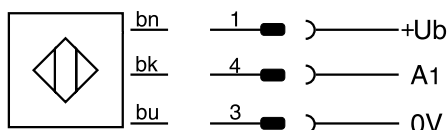

PIN ASSIGNMENT

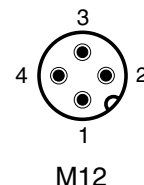

AVAILABLE TYPES

Part number	Part reference	Polarity	Connection	Output (A1)	Output (A2)
620 600 194	LLR-M18PA-NMK-400	Emitter	PVC, 2 m, 3-wire	IO-Link	-
620 600 195	LLR-M18PA-NMS-400	Emitter	Connector M12 4-pin	IO-Link	-
620 600 196	LLR-M18PA-NMK-404	PNP	PVC, 2 m, 3-wire	Dark-on/IO-Link	-
620 600 197	LLR-M18PA-NMK-603	PNP	PVC, 2 m, 4-wire	Light-on/IO-Link	Dark-on
620 600 198	LLR-M18PA-NMK-60D	PNP	PVC, 2 m, 4-wire	Dark-on/IO-Link	Stability alarm
620 600 199	LLR-M18PA-NMK-302	NPN	PVC, 2 m, 3-wire	Dark-on	-
620 600 200	LLR-M18PA-NMK-101	NPN	PVC, 2 m, 4-wire	Light-on	Dark-on
620 600 201	LLR-M18PA-NMK-10B	NPN	PVC, 2 m, 4-wire	Dark-on	Stability alarm
620 600 202	LLR-M18PA-NMS-404	PNP	Connector M12 4-pin	Dark-on/IO-Link	-
620 600 203	LLR-M18PA-NMS-603	PNP	Connector M12 4-pin	Light-on/IO-Link	Dark-on
620 600 204	LLR-M18PA-NMS-60D	PNP	Connector M12 4-pin	Dark-on/IO-Link	Stability alarm
620 600 205	LLR-M18PA-NMS-302	NPN	Connector M12 4-pin	Dark-on	-
620 600 206	LLR-M18PA-NMS-101	NPN	Connector M12 4-pin	Light-on	Dark-on
620 600 207	LLR-M18PA-NMS-10B	NPN	Connector M12 4-pin	Dark-on	Stability alarm

Note: additional suffix can appear to indicate a revision version or a special version.

Operators of the products we supply are responsible for compliance with measures for the protection of persons. The use of our equipment in applications where the safety of persons might be at risk is only authorized if the operator observes and implements separate, appropriate and necessary measures for the protection of persons and machines. Terms of delivery and rights to change design reserved.

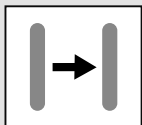

30'000 mm

- ✓ Boîtier court M18
- ✓ IO-Link
- ✓ Réglage de la sensibilité via IO-Link
- ✓ Domaine calibré
- ✓ Choix de séquence d'émission via IO-Link

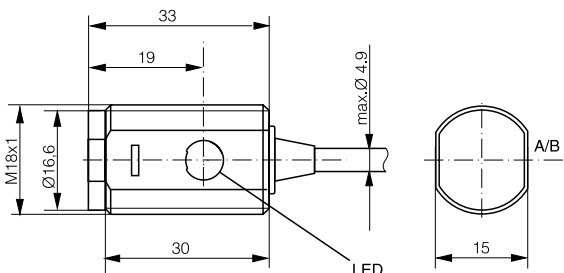
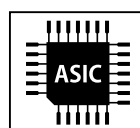

A: axe de l'émetteur B: axe du récepteur

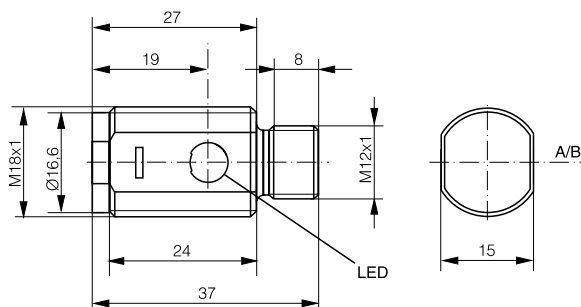

A: axe de l'émetteur B: axe du récepteur

DONNÉES OPTIQUES		INTERFACE	
Domaine de détection typ. max.	0...30'000 mm	Réglage sensibilité	7'000...30'000 mm, IO-Link
Domaine de fonctionnement	0...25'000 mm	Indicateur LED, vert	Réserve de fonctionnement
Source lumineuse	LED, rouge 630 nm	Indicateur LED, jaune	Etat de détection
Taille tache lumineuse (distance)	Ø 35 mm (500 mm)/Ø 250 mm (6 m)/ Ø 1'000 mm (25 m)	IO-Link	✓

DONNÉES ÉLECTRIQUES		DONNÉES MÉCANIQUES	
Tension d'alimentation (U _b)	10...30 VDC	Indice de protection	IP67
Ondulation résiduelle	≤ 10 Vpp	Temp. ambiante d'utilisation	-25...+65°C
Courant de sortie	≤ 200 mA	Chocs et vibrations	IEC 60947-5-2
Tension de sortie haut/bas (PNP)	≤ (U _b -2.0 V)/ approx. 0 V	Poids (version connecteur)	6 g
Tension de sortie haut/bas (NPN)	Approx. U _b / ≤ 2.0 V	Poids (version câble)	71 g
Consommation (hors charge)	≤ 7 mA (emitter)/≤ 13 mA (receiver)	Matériau du boîtier	ABS
Temps de réponse	≤ 500 µs (normal)/≤ 1 ms/≤ 250 µs	Matériau de la fenêtre	PMMA
Fréquence de commutation	≤ 1 kHz (normal)/≤ 500 Hz/≤ 2 kHz	Câble de raccordement	PVC, 2 m, 3 fils ou 4 fils
Protection contre les courts-circuits	✓	Type de connecteur	M12 4 pins
Protection contre les inversions	✓		

¹Par défaut, mode "Normal". Modes "Fine" et "Fast" sélectionnables via IO-Link.

RÉSERVE DE FONCTIONNEMENT

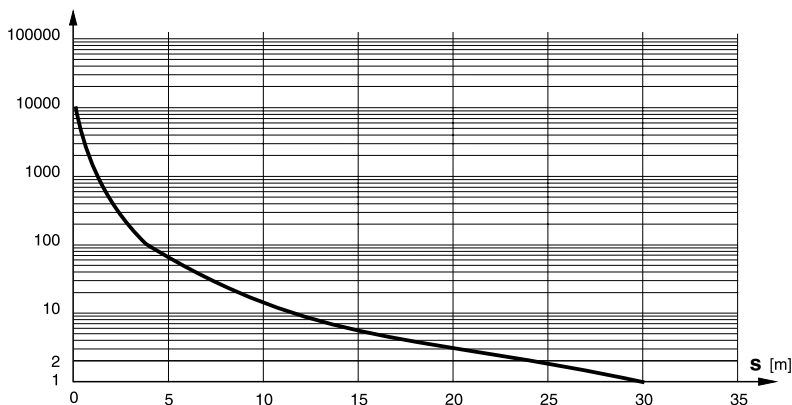

FONCTIONNALITÉS IO-LINK

SORTIE ALARME DE STABILITÉ (A2)

Version IO-Link	1.0
Mode SIO	Disponible
Process data	Etat de détection et alarme stabilité
Baudrate	COM2 (38.4 kBaud)
Fonctions spéciales	Configuration sortie, temporisation sortie, sensibilité, mode du capteur, compteur de détections, flags d'erreur, température max. et actuelle du capteur

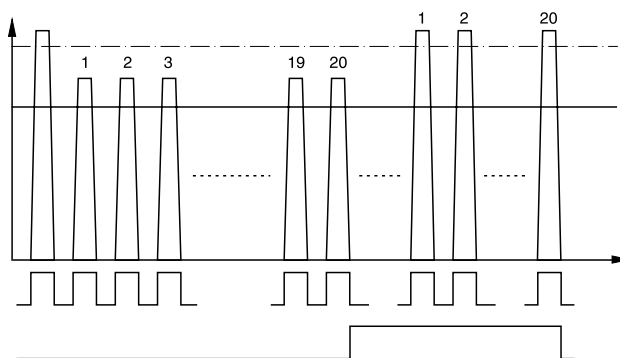

Les spécifications IO-Link et les fichiers IODD peuvent être téléchargés depuis www.contrinex.com (onglet Télécharger)

SCHÉMA DE RACCORDEMENT

ATTRIBUTION DES PINS

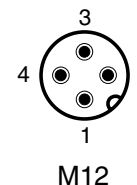
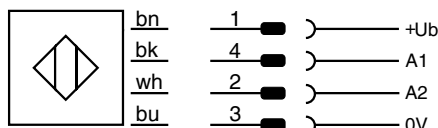
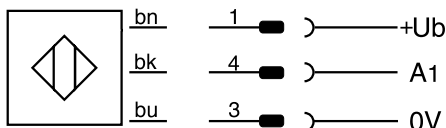

TYPES DISPONIBLES

Numéro d'article	Désignation	Polarité	Raccordement	Sortie (A1)	Sortie (A2)
620 600 194	LLR-M18PA-NMK-400	Émetteur	PVC, 2 m, 3 fils	IO-Link	-
620 600 195	LLR-M18PA-NMS-400	Émetteur	Connecteur M12 4 pins	IO-Link	-
620 600 196	LLR-M18PA-NMK-404	PNP	PVC, 2 m, 3 fils	Sans réception/IO-Link	-
620 600 197	LLR-M18PA-NMK-603	PNP	PVC, 2 m, 4 fils	En réception/IO-Link	Sans réception
620 600 198	LLR-M18PA-NMK-60D	PNP	PVC, 2 m, 4 fils	Sans réception/IO-Link	Alarme de stabilité
620 600 199	LLR-M18PA-NMK-302	NPN	PVC, 2 m, 3 fils	Sans réception	-
620 600 200	LLR-M18PA-NMK-101	NPN	PVC, 2 m, 4 fils	En réception	Sans réception
620 600 201	LLR-M18PA-NMK-10B	NPN	PVC, 2 m, 4 fils	Sans réception	Alarme de stabilité
620 600 202	LLR-M18PA-NMS-404	PNP	Connecteur M12 4 pins	Sans réception/IO-Link	-
620 600 203	LLR-M18PA-NMS-603	PNP	Connecteur M12 4 pins	En réception/IO-Link	Sans réception
620 600 204	LLR-M18PA-NMS-60D	PNP	Connecteur M12 4 pins	Sans réception/IO-Link	Alarme de stabilité
620 600 205	LLR-M18PA-NMS-302	NPN	Connecteur M12 4 pins	Sans réception	-
620 600 206	LLR-M18PA-NMS-101	NPN	Connecteur M12 4 pins	En réception	Sans réception
620 600 207	LLR-M18PA-NMS-10B	NPN	Connecteur M12 4 pins	Sans réception	Alarme de stabilité

Remarque: la présence d'un suffixe supplémentaire indique une version révisée ou une version spéciale.

Les exploitants des produits que nous fournissons sont tenus d'assurer des mesures adéquates de protection des personnes. L'utilisation de nos appareils dans des applications comportant un risque possible pour la sécurité des personnes n'est admissible que si l'exploitant observe et met en œuvre des mesures séparées, appropriées et nécessaires pour la protection des personnes et des machines. Sous réserve de modifications et de possibilités de livraison.

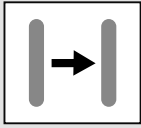

30'000 mm

- ✓ Kurzes M18 Gehäuse
- ✓ IO-Link
- ✓ Empfindlichkeitseinstellung via IO-Link
- ✓ Kalibrierter Bereich
- ✓ Sendesequenzwahl via IO-Link

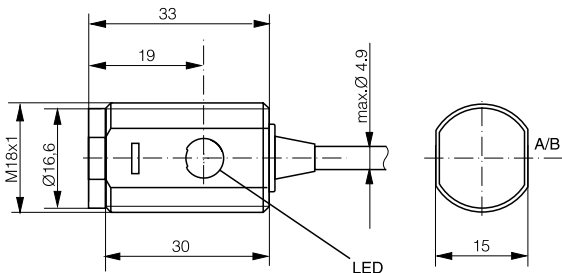
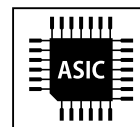

A: Senderachse B: Empfängerachse

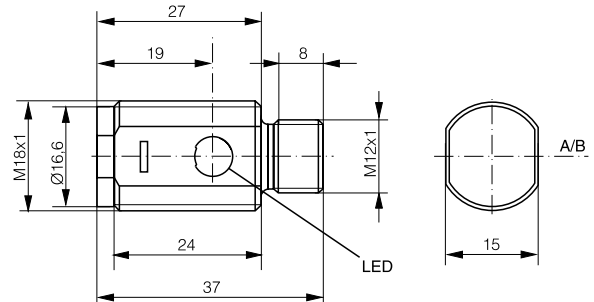

A: Senderachse B: Empfängerachse

OPTISCHE DATEN		INTERFACE	
Erfassungsbereich typ. max.	0...30'000 mm	Empfindlichkeitseinstellung	7'000...30'000 mm, IO-Link
Arbeitsbereich	0...25'000 mm	Anzeige-LED, grün	Funktionsreserve
Lichtquelle	LED, rot 630 nm	Anzeige-LED, gelb	Erfassungsstatus
Lichtfleckgrösse (Entfernung)	Ø 35 mm (500 mm)/Ø 250 mm (6 m)/ Ø 1'000 mm (25 m)	IO-Link	✓

ELEKTRISCHE DATEN		MECHANISCHE DATEN	
Versorgungsspannung (Ub)	10...30 VDC	Schutzart	IP67
Restwelligkeit	≤ 10 Vpp	Umgebungstemperatur Betrieb	-25...+65°C
Ausgangsstrom	≤ 200 mA	Schocks und Vibrationen	IEC 60947-5-2
Ausgangsspannung high/low (PNP)	≤ (Ub-2.0 V)/ ca. 0 V	Gewicht (Steckerversion)	6 g
Ausgangsspannung high/low (NPN)	ca. Ub/ ≤ 2.0 V	Gewicht (Kabelversion)	71 g
Stromaufnahme (ohne Last)	≤ 7 mA (Sender)/≤ 13 mA (Empfänger)	Gehäusematerial	ABS
Ansprechzeit	≤ 500 µs (normal)/≤ 1 ms/≤ 250 µs	Fenstermaterial	PMMA
Schaltfrequenz	≤ 1 kHz (normal)/≤ 500 Hz/≤ 2 kHz	Anschlusskabel	PVC, 2 m, 3- oder 4-adrig
Kurzschlusschutz	✓	Anschlusstecker	M12 4-Pin
Verpolungsschutz	✓		

*Standardmässig im "Normal"-Modus. "Fine"- und "Fast"-Modus wählbar über IO-Link.

FUNKTIONSRERVE

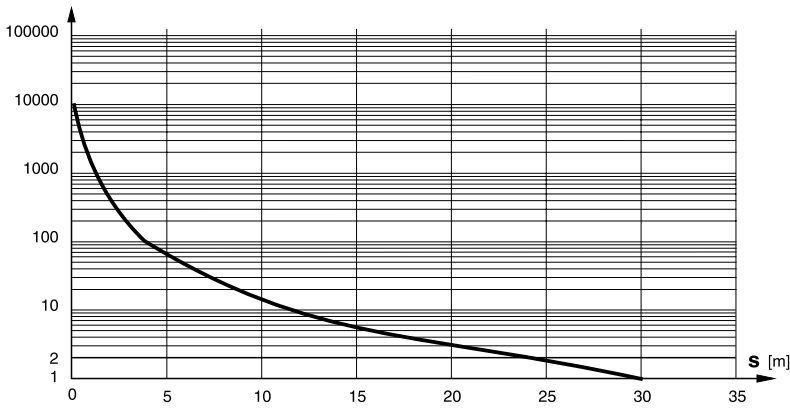

IO-LINK-FUNKTIONALITÄTEN

AUSGANG STABILITÄTSALARM (A2)

IO-Link-Version	1.0
SIO-Modus	Unterstützt
Prozessdaten	Erfassungsstatus u. Stabilitätsalarm
Baudrate	COM2 (38.4 kBaud)
Sonderfunktionen	Ausgang Konfiguration, Schaltverzögerung, Empfindlichkeit, Sensormodus, Erfassungscounter, Event-Flags, maximale u. aktuelle Sensortemperatur

IO-Link-Spezifikationen und IODD-Dateien werden von www.contrinex.com heruntergeladen (Register Download)

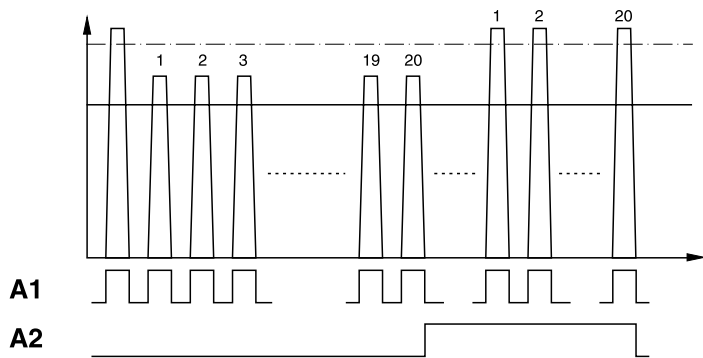

ANSCHLUSSSCHEMA

STECKERBELEGUNG

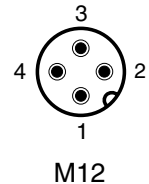
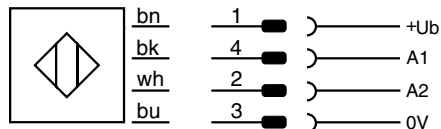
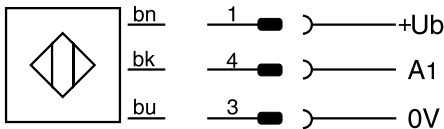

VERFÜGBARE TYPEN

Artikelnummer	Bezeichnung	Schaltung	Anschluss	Ausgang (A1)	Ausgang (A2)
620 600 194	LLR-M18PA-NMK-400	Sender	PVC, 2 m, 3-adrig	IO-Link	-
620 600 195	LLR-M18PA-NMS-400	Sender	Stecker M12 4-Pin	IO-Link	-
620 600 196	LLR-M18PA-NMK-404	PNP	PVC, 2 m, 3-adrig	Dunkelschalt./IO-Link	-
620 600 197	LLR-M18PA-NMK-603	PNP	PVC, 2 m, 4-adrig	Light-on/IO-Link	Dunkelschaltend
620 600 198	LLR-M18PA-NMK-60D	PNP	PVC, 2 m, 4-adrig	Dunkelschalt./IO-Link	Stabilitätsalarm
620 600 199	LLR-M18PA-NMK-302	NPN	PVC, 2 m, 3-adrig	Dunkelschaltend	-
620 600 200	LLR-M18PA-NMK-101	NPN	PVC, 2 m, 4-adrig	Hellschaltend	Dunkelschaltend
620 600 201	LLR-M18PA-NMK-10B	NPN	PVC, 2 m, 4-adrig	Dunkelschaltend	Stabilitätsalarm
620 600 202	LLR-M18PA-NMS-404	PNP	Stecker M12 4-Pin	Dunkelschalt./IO-Link	-
620 600 203	LLR-M18PA-NMS-603	PNP	Stecker M12 4-Pin	Hellschaltend/IO-Link	Dunkelschaltend
620 600 204	LLR-M18PA-NMS-60D	PNP	Stecker M12 4-Pin	Dunkelschalt./IO-Link	Stabilitätsalarm
620 600 205	LLR-M18PA-NMS-302	NPN	Stecker M12 4-Pin	Dunkelschaltend	-
620 600 206	LLR-M18PA-NMS-101	NPN	Stecker M12 4-Pin	Hellschaltend	Dunkelschaltend
620 600 207	LLR-M18PA-NMS-10B	NPN	Stecker M12 4-Pin	Dunkelschaltend	Stabilitätsalarm

Hinweis: Im Fall einer überarbeiteten Version oder Sonderausführung kann die Bezeichnung auch durch eine Endung ergänzt werden.

Die Einhaltung der Personenschutzmaßnahmen obliegt dem Betreiber der von uns gelieferten Produkte. Der Einsatz unserer Geräte in Anwendungen, bei welchen die Sicherheit von Personen gefährdet sein könnte, ist nur dann zulässig, wenn der Betreiber gesonderte geeignete und notwendige Maßnahmen für die Personen- und Maschinensicherheit einhält und vornimmt. Änderungen und Liefermöglichkeiten vorbehalten.